

# The Quad ESL Refurbishing Picture Book

Sheldon D. Stokes Ph.D.

stokes@spinn.net  
<http://www.quadesl.com>

November 3, 2000

Dedicated to my loving and tolerant wife. And my parents who instilled a sense of wonder and a confidence to try things that seemed difficult or impossible. It is also dedicated to my dog Madison, who's enthusiasm and zest for life keeps me young.



# Chapter 1

## Introduction



The Quad ESL <sup>1</sup>, introduced in 1957, has become a true icon in the realm of high performance audio. It was revolutionary when it was introduced, the first production full range electrostatic speaker. For many, it was a revelation, the first uncolored speaker capable of showing what was really buried in those LP's and tapes. For others it was a quirky little speaker that couldn't play loudly, and was bass shy.

The Quad ESL, when working properly is capable of stunning bass performance down to about 40 Hz or so depending on SPL. The bass is clean and tight, free from box colorations and boom which is very common with box style moving coil speaker systems. The high frequencies are very directional, and on axis extend to 20 KHz. The transient performance is amazing even by modern standards.

The limitations of the Quad ESL are in it's limited SPL performance and it's directional radiation pattern. It is capable of about 100 dB and not much more. Any attempts to push it louder will compress the transient peaks and run the risk of damaging the speaker. However 100 dB is more than ample volume level for most all listening situations. The other limitation of the speaker is that the high frequencies are directional. This means that to enjoy the full range sound capable of the speaker, one needs to be sitting on axis with the speaker. This can actually be a good thing because there is very little energy projected off axis and this corresponds to few side wall reflections and a speaker which excites room resonances less than many box speakers.

The Quad ESL is capable of reproducing vocals with a realism and clarity that

---

<sup>1</sup>Also called the ESL 57 to distinguish it from the newer and very different ESL 63. In this text, I will refer to the ESL 57 as the original ESL or just the Quad ESL.

is unrivaled, even by modern speakers that have the benefit of forty plus years of technology advancement and larger final costs.

Chances are that if you are interested in the Quad ESL and this book, you are one of the people who understand the magic of the Quad ESL, and I am “Preaching to the choir” so to speak. Many words have been written about the amazing performance of the original Quad ESL’s. I won’t repeat it here, but I will say that listening to a set of properly working ESL’s through high resolution electronics will be an amazing experience for just about anybody.

Quad stopped supporting the original ESL, in the early 1990’s. This left a lot of ESL owners without replacement parts. This is particularly bad considering that the tweeter panels are easy to overpower and arc. The ESL’s were designed in a time when 15 watts was a lot of power. As amplifiers got more and more powerful, tweeter burn out became a real issue with folks who pushed the speakers too hard or had electrical failures in the electronics chain leading to the speakers. The treble panels, also called *trouble* panels by some audiophiles, are the weakest link in the everyday operation of the ESL’s. The power supplies can have problems due to aging of the rectifier diodes. The dust covers can become brittle and split. But none of those problems will stop a set of ESL’s faster than an inadvertent twist of the volume dial. Later in the book, I will describe a couple circuits which will protect the fragile tweeter panels. This book represents refinements to the rebuild techniques that I described my *Positive Feedback* article and my web site.

Using the directions and illustrations provided in this text, a pair of quad ESL’s can be repaired and kept in perfect working condition for many decades to come, using only readily available tools and materials.

**WARNING:** High voltages are present inside the speaker. This presents real and possibly lethal dangers. If you are not comfortable with working around high voltages or do not know the proper safety procedures, never work on a charged speaker. If the power is disconnected from the speaker and it is allowed to sit overnight, the speaker will discharge and will be safe. *Never* work on the speaker with an audio signal connected to the input transformer. Disconnect the speaker wires before touching anything inside the speaker. When working on a charged speaker, it is best to keep one hand behind your back at all times. This will prevent any possible shock from traveling through your heart.

## Chapter 2

# General ESL Operation

Electrostatic Speakers are conceptually very simple devices, an electrical diagram is shown in figure 2.1. The heart of the speaker is a stretched thin film diaphragm that is suspended between perforated conductive stator panels. The distance between the stators and the diaphragm is typically small, on the order of 1/16th to 1/8th of an inch for the treble and bass panels respectively. The diaphragm is coated with a slightly electrically conductive coating. The coating should only be slightly conductive. The diaphragm is charged via the power supply. Typically the diaphragm is charged to several thousand volts above the stator panels, in the case of the Quad ESL, 1500 volts for the tweeter panel and 6000 volts for the bass panel. There is no current flow however because the diaphragm is insulated from the stators. The audio signal drives a step-up transformer that increases the voltage of the signal 90 times for the tweeter and 270 times for the bass panel. The output of the transformer is connected to the stator panels. Potential difference across the stators causes an electrical field (a linear field too) between the stators and this causes the diaphragm to be pushed and pulled toward one of the stators by electrostatic force. There is a crossover network that diverts the different frequency signals to the respective panels. It is important to note that the transformer itself is part of the crossover network. It is also important to point out that the crossover operates in the kilovolt range, which makes component replacement limited to only devices that can handle very high voltages. The advantages to this system is that the diaphragm is very light, so it is capable of reproducing the entire spectrum of audio. The diaphragm is also uniformly driven, so it moves in a very controlled linear fashion. The diaphragm is also very light, and its spring constant is high, so the diaphragm couples very well to the air it's driving, so it's also well damped. Some of the disadvantages are that the audio signal is put through a transformer. And due to cancellation effects that plague all dipoles, they must be physically large to produce any bass at all.

Due to limitations at the time of design, the Quad ESL is made up of three panels. Using a sectionalized approach allows the speaker to be more efficient,

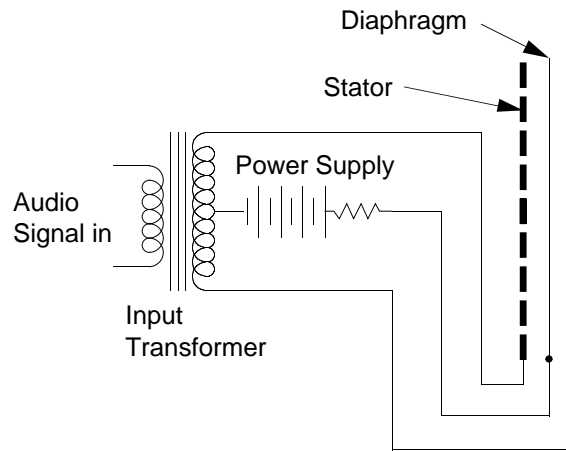


Figure 2.1: Basic Electrostatic Loudspeaker Components

and the treble to be more dispersive (this speaker was designed back when 15 watts was a lot of power).

The schematic for the later model Quad ESL is shown in figure 2.2. The left side of the schematic (shown within the dotted box) is power supply which is bolted to the right side of the speaker when viewed from the back. The right side of the schematic (within the dotted box) is the input transformer and crossover assembly. The schematic shown represents the more modern crossover design, this is the correct schematic for speakers S/N 16000 and onward. Older speakers didn't have the capacitive coupling to the tweeter center section. This was added in an attempt to improve the tweeter power handling and durability. It may have helped some, but not enough. The schematic for the older Quad ESL is shown in figure 2.3. Quad service centers modified the older style crossover with an additional small tagboard to add the extra few components if a customer wanted that service. The modification consists of a small tagboard bolted under the original style crossover tagboard.

The individual panels are comprised of 5 parts as seen in figure 2.4. At the center is a thin Mylar or saran (for the tweeter and bass panels respectively) diaphragm tensioned and attached to one of the two hollow perforated stator panels, which are shown on either side of the diaphragm. The charged diaphragm will attract dust in due to the same electrostatic forces as the diaphragm is attracted to the stators. Essentially the charged diaphragm is a big dust magnet. Without protection, the panel assembly will fill up with dust to the point that the dust will short out the panel and it will cease to work. To avoid this problem, Quad placed thing stretched mylar or saran dust covers on either side of the stator panels as seen in figure 2.4. These dust covers are stretched onto wooden frames. The two frames are placed on either side of the stator diaphragm assembly and taped around the perimeter.

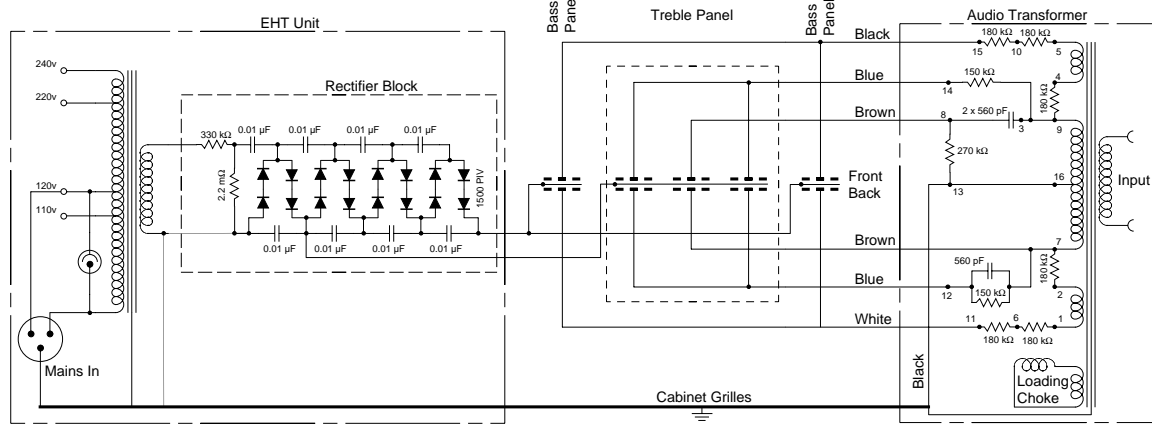


Figure 2.2: New Style Quad ESL Schematic

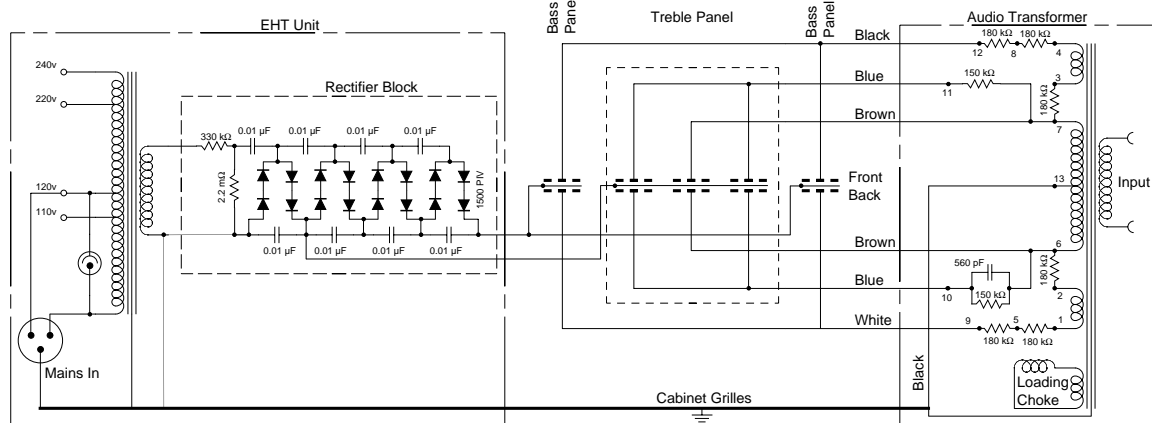


Figure 2.3: Old Style Quad ESL Schematic

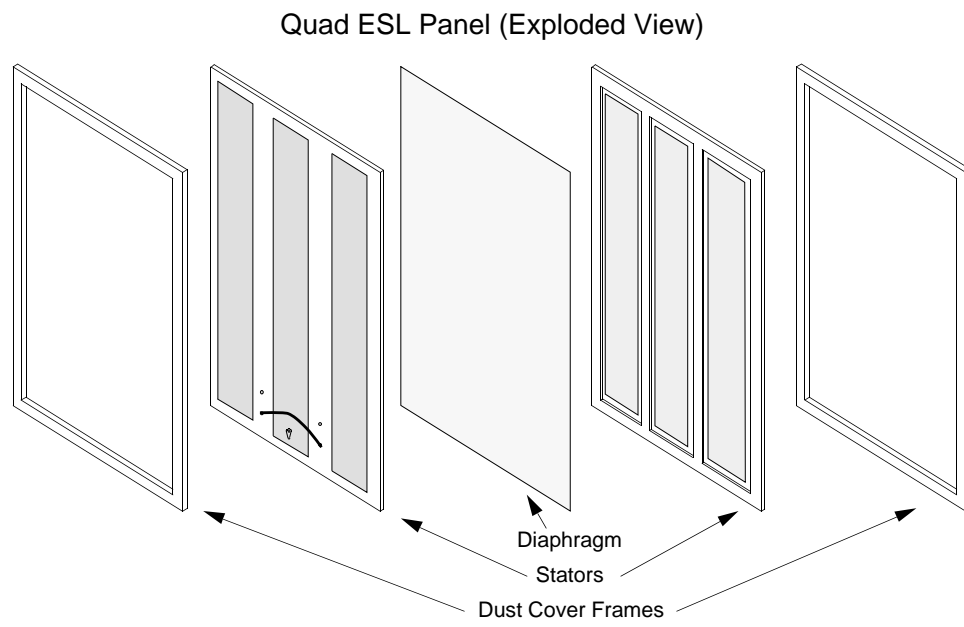


Figure 2.4: Quad ESL Panel block diagram



## Chapter 3

# Major Parts & Disassembly

The Quad ESL is relatively easy to disassemble, but care should be taken not to damage the thin front grille and not to damage the panel dust covers if they are not going to be replaced. The first step is to remove the three wooden feet, this is done by gently laying the speaker on its front grille on any padded surface. The feet are held to the frame by four wood screws each. The feet are typically punched with the a letter on the contact area of the foot to indicate its proper position on the frame. When the speaker is placed face down, the foot marked “R” is actually on the left when facing the bottom of the speaker, similarly the foot marked “L” is located on the right side. The center rear foot is not marked.

After the feet have been removed, the speaker can be tipped up onto the base of the frame. The wooden side panels (or trim panels) can then be removed, this is shown in figure 3.1. Many speaker left the factory with screws for the side panels that are too long and actually screw into the sides of the bass panels. In some cases this damages the panels. IT is advised to either buy slightly shorter wood screws or grind an eighth to a quarter of an inch off the end of each screw. After the bass panels have been removed, the sides of the panels can be inspected to determine of the trim screws are too long.

Before the front and rear grilles can be removed, they must be disconnected from the power supply ground. There are a pair of bare wires that connect the front and rear grilles tot he power supply. These are located under the frame base and are shown being cut in figure 3.2. Rather than cutting these wires, they can also be unsoldered from the eyelets on each grille.

After the grounds have been removed, the back grille can be removed by unscrewing the screws around the parameter of the grille. The rear grille can then be carefully removed from the frame.

After the grille is removed, all the basic components of the ESL can then be clearly seen. An ESL with the rear grille is shown in figure 3.3. The assembly on the right frame base is the bias voltage power supply and is also shown in figure 3.4. This power supply will be described in mor detail in the power supply

chapter. The input transformer and crossover is located in the metal box bolted to the frame base on the left side, and is also shown in figure 3.5. Also shown here in figure 3.6 is a broken input banana connector. Quad used plastic input connectors that can be, and often are, broken or loose. The treble panel is in the center and is covered by felt damping material. On either side of the treble panel is a bass panel. The panels are removed from the front of the speaker after the power supply and the input transformer are removed.

If the panels are to be removed, the front grille has to be removed. The front grille is removed by first removing the staples along each side as seen in figure 3.7. This is easily done with a small screwdriver and a pair of needle nose pliers. Then the screws that retain the front grille along it's bottom edge must be removed, as seen in figure 3.8. This is most easily done by gently laying the speaker on a padded surface so that the front grille is facing upward. The grille can then be removed by starting at the bottom and gently pulling the grille away from the frame. IT is attached at the top of the frame by curving around the top edge and sliding into a recessed slot along the top rear of the frame. The grille can be carefully worked out of that slot being careful not to unbend the grille too much. Figure 3.9 shows the front of an ESL with the front grille removed.

After the front grille is removed, the two foam strips that support the front grille in the center can be carefully removed from the sides of the treble panel. This is shown in figure 3.10.

After the foam strips are removed, the panel retaining brackets can then be unscrewed from the frame as seen in figure 3.11. There are two wood screws that attach each bracket to the wooden frame.

After this is complete, the speaker can be turned around and the power supply and input transformer removed. The input transformer is attached to the frame via four screws through the base of the frame. It is most easily removed by unscrewing the four screws while the speaker is in a vertical position by sliding the speaker slightly over the edge of the work surface as shown in figure 3.12. The power supply is also attached to the frame by four screws through the base of the frame. These are removed in a similar manner to the input transformer as shown in figure 3.13.

After the power supply screws have been removed, the whole power supply assembly can be slid backward away from the bass panel, and the electrical connections can be unsoldered as shown in figure 3.14. If the bass panel isn't going to be removed and rebuilt, care should be taken to protect the panel and fragile dust cover from the un-soldering operation. this is easily done by draping a towel over the top of the frame and tucking the end of the towel between the power supply and the bass panel. This will protect the panel and dust cover in the even that any solder flies from the power supply as it is being unsoldered. After the four wires are unsoldered, the power supply can be removed and set aside. The power supply rebuilding will be discussed at length in the power supply chapter.



Figure 3.1: Removal of Wooden Trim Strips

After the input transformer screws have been removed, the transformer box can be tipped on its side and the ground and panel connections unsoldered, as shown in figure 3.15. After the wires are unsoldered, and pulled through the grommet in the input transformer box, the transformer assembly can be set aside. After the input transformer is removed, the left side of the speaker will look as shown in figure 3.16.

After both the power supply and the input transformer have been removed, the bass panel terminal boards are accessible, and the wires from them can be unsoldered. First the insulating tubing needs to be cut away from the center bias supply connection as shown in figure 3.17. The connections to the bass panel can then be unsoldered as shown in figure 3.18. If the panel or dust cover is not going to be rebuilt, extreme care should be taken when un-soldering not to melt the dust cover or allow any molten solder to splash the dust cover. The dust cover is protected by placing a piece of notebook paper between the terminal board and the dust cover.

After the bass panels have been unsoldered, they can be removed by sliding each panel toward the center of the frame. A screwdriver can be used to carefully push the panels inward as shown in figure 3.19. The panels are held in place on the sides by a lip in the frame, and at the top and bottom on the outside by “L” shaped brackets. They are held on the inside by the brackets removed earlier. The treble panel is held in place by the bass panels in front of it, and by short pins attached to wooden braces that pierce the dust cover frame behind it. The treble panel can be easily removed after the two bass panels are removed.



Figure 3.2: Cut Grille Grounding Wires



Figure 3.3: ESL With Back Grille Removed



Figure 3.4: ESL Power Supply Assembly



Figure 3.5: ESL Input Transformer Assembly



Figure 3.6: Broken Input Banana Connector



Figure 3.7: Removal of Front Grille Staples



Figure 3.8: Removal of Front Grille Retaining Screws



Figure 3.9: ESL With Front Grille Removed



Figure 3.10: Removal of Front Grille Foam Padding



Figure 3.11: Removal of Panel Retaining Brackets



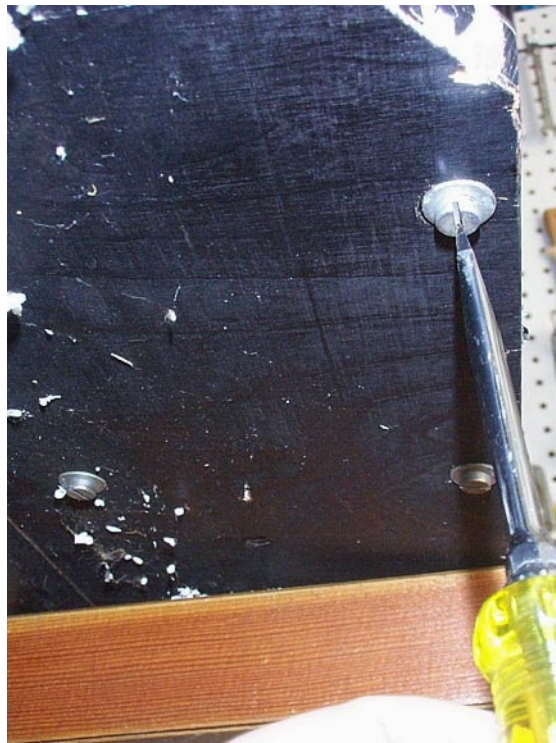


Figure 3.12: Removal of Input Transformer Retaining Screws



Figure 3.13: Removal of Power Supply Retaining Screws



Figure 3.14: Unsolder Power Supply Connections



Figure 3.15: Unsolder Input Transformer Connections

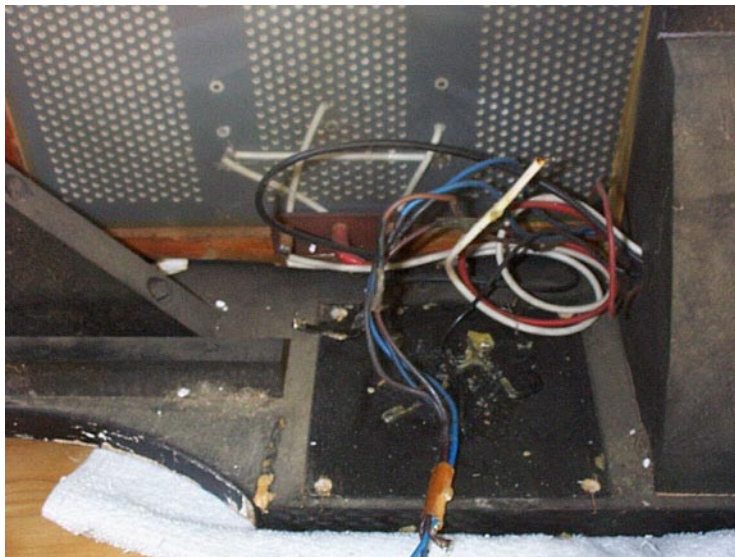


Figure 3.16: Input Transformer Assembly Removed



Figure 3.17: Cut Bias Wiring Insulation



Figure 3.18: Unsolder Bass Panel Connections



Figure 3.19: Removal of Bass Panel



# Chapter 4

## Bass Panels

### 4.1 Disassembly

Both the bass and treble panels are rebuilt in essentially the same way. The electrical connections differ between the panels and this changes the rebuilding subtleties somewhat. However, the basic technique is the same.

The major failure mode for bass panels is either the diaphragm getting brittle and splitting, or the dust cover splitting and not being repaired. This will allow the bass panel to fill with dust and dirt which is electrostatically attracted to the panel assembly just like the diaphragm is attracted to the stators.

Figure 4.1 shows a set of bass panels removed from the speaker frames. These panels are typical of the external condition seen in many quads. The left panel shows the front dust cover where someone has repaired a tear or split with tape. This is probably the best method for simple repairs although it's not an elegant solution, and a better idea is to replace the whole dust cover. The right panel in figure 4.1 shows the rear dust cover which has torn around the electrical terminal strip.

The first step in rebuilding a bass panel is to cut the tape holding the two dust covers to the stators. The dust covers are taped all around the panel sides. An effective method is to use a razor blade knife as shown in figure 4.2. The razor blade should slide easily in the space between the wooden dust cover frame and the plastic stator panel. The blade is pulled around the perimeter for each dust cover. The front dust cover is then free and can be set aside. The rear dust cover is still attached to the stator assembly by the electrical connections.

The front and rear stator halves each have an electrical connection riveted to the bottom center of the panel. The wires from each of these terminals should be carefully unsoldered. Care should be taken to apply heat to the strip for as short a time as necessary to remove the wire as the terminal strip is attached to the plastic stator which can easily melt if too much heat is applied. Figure 4.3 and figure 4.4 show the un-soldering operations. After these two wires are unsoldered, the

bias supply wire must be removed, it is attached to a wiring harness and bolted through two rivets on the panel. A small screwdriver or a wrench is used to remove this wiring harness. Figure 4.5 shows this wiring harness and the wrench used to remove the small nut and bolt. After the nut and bolts are removed the rear dust cover should be free from the stator assembly, and the rear dust cover can be set aside to be recovered later.

The sides of the stators are also covered in tape. This is to insulate the stators and the rivets from the wooden dust cover frames. At high voltages wood is fairly conductive, and will short out the bias voltage on the panel. This tape is needed because the entire diaphragm is coated even under the rivet areas as well as the edges of the diaphragm sticking out the sides of the stators. The new diaphragm will not be coated in this area, and the risk of shorting out the diaphragm will be reduced, but insulating tape will be added anyway as a precaution. This old insulating tape needs to be removed to expose the rivets that are holding the stators together. Figure 4.6 shows that bass panel tape being peeled away. This tape is typically very old and the adhesive has deteriorated and it is very easy to remove. The adhesive turns to dust.

After the tape has been removed the next step is to drill or push out the rivets. The rivets can also be carefully ground away. Drilling the rivets out is the easiest method, it enlarges the rivet holes slightly, but that isn't a problem. A 9/64 inch drill bit works very well, figure 4.7 shows a rivet being drilled out. Care needs to be taken when drilling out the rivets, especially in the corners, that only light drill pressure be used to prevent cracking the stators. Care also needs to be taken to prevent the drill from crashing down on the stator when the rivet drops free, this can also crack the stator.

There are two rivets that should not be drilled out. They are the rivets that are under the nut and bolts that held on the bias supply wiring harness. These are rivets that only rivet into each stator half and do not prevent the stators from separating. After all the rivets have been removed, the two stators can be carefully pulled apart. This will reveal the diaphragm and years of dirt and dust. You may find that the coating on the diaphragm looks uneven, like it was applied haphazardly, and in many cases it probably was. Figure 4.8 shows the bass panel diaphragm and the uneven coating.

The bass panel diaphragm can now be removed from the rear stator. It can be removed by cutting it in the center and pulling pieces of the diaphragm toward the edges. Another trick is to tape the perimeter of the diaphragm with good sticky masking or packing tape, and then pull the diaphragm up by the tape. The diaphragm will usually come off cleanly and in one piece that way. Figure 4.9 illustrates this technique. At this point the stator panels are ready to be cleaned and have a new diaphragm installed. If all four bass panels are disassembled at the same time, it's a good idea to number the panel pairs so they can be reassembled as the same pairs. The rivets were not installed with the precision that will allow





Figure 4.1: Quad ESL Bass Panels

different stators to be interchanged.

## 4.2 Stator Inspection and Repair

Bass panel stators rarely arc badly enough to melt the plastic. The real problem with the bass panel stators are that the insulating grey paint starts to flake off and make a mess. This isn't really a big issue and all that needs to be done is to take a stiff brush and remove any of the loose paint and vacuum out the stators. On rare occasions, particularly in very humid or salt air conditions, do the stator panels conductive coating corrode. This corrosion produces conductive oxides, which can be seen as a white salty looking residue. This should be cleaned off with a stiff brush or a scraper using a light touch, the silver conductive tap on the inside of the stators corrodes under these conditions. The panel should be wiped down on the inside with isopropyl alcohol (either 91% or 99% pure obtained from a large drug store), when corrosion is seen on this silver tape, as the oxides can form tracks that cause panel shorts.



Figure 4.2: Removing The Dust Covers



Figure 4.3: Un-soldering Rear Bass Stator Wire



Figure 4.4: Un-soldering Front Bass Stator Wire



Figure 4.5: Removing The Bass Bias Wiring Harness

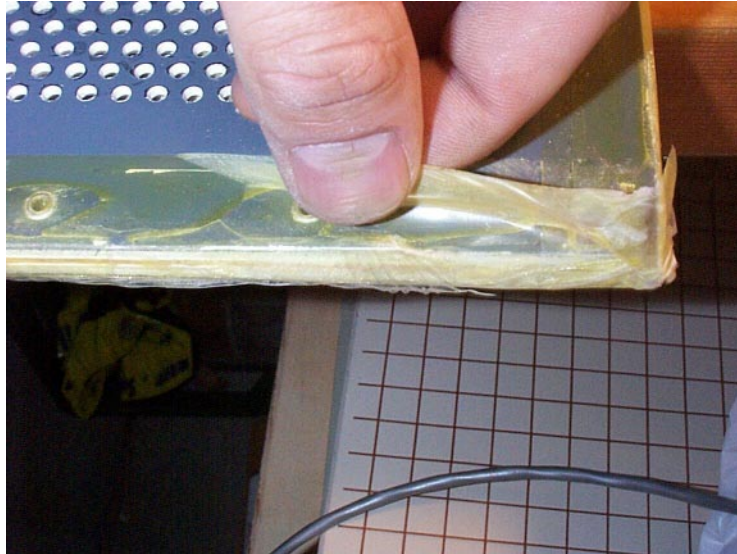


Figure 4.6: Removing The Bass Stator Insulating Tape



Figure 4.7: Drilling A Bass Panel Rivet

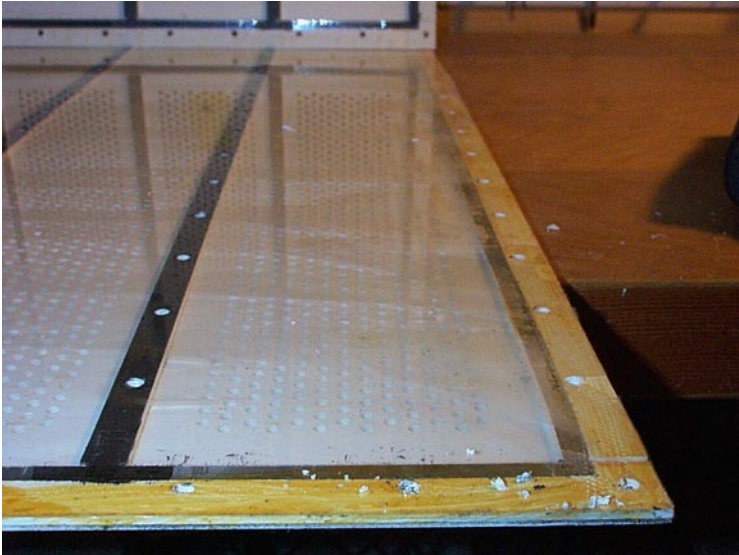


Figure 4.8: Bass Panel Diaphragm

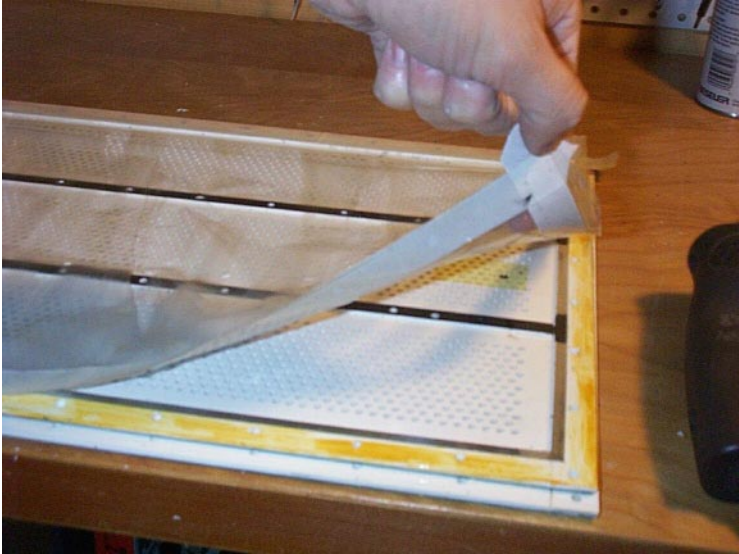


Figure 4.9: Removing The Bass Panel Diaphragm

### 4.3 Diaphragm Replacement

After the stators have been cleaned and inspected, the next step is to install a replacement diaphragm. The original Quad bass diaphragms were a saran type material that has a lower modulus of elasticity than the mylar used for the tweeter panels. This allows that bass panel to have a lower resonant frequency. It is a material very similar to the bass panel dust covers. A replacement material which has nearly identical properties can be obtained from hardware or home stores. It is used to insulate older windows against winter cold. The material is marketed by 3M, Frost King, Ace and others. The window plastic comes in a thinner indoor use variety and a thicker outdoor use type. The thinner variety is the ideal gauge. This film is very easy to use and is heat shrunk with an ordinary hair dryer.

The film must be held flat and slightly tensioned to remove wrinkles prior to being glued to the rear stator. To do this, a stretching jig can be built, as seen in figure 4.10 and a photo of a completed jig can be seen in figure 4.11. The design show has the ability to tightly tension the diaphragm by tightening the wing nuts. This isn't necessary if the bass and treble panel diaphragms are tensioned by heat shrinking. The jig has two sized top and bottom sections, for bass and treble panels.

The diaphragm replacement process is started by first cutting a piece of the saran film to the size of the jig. The film is then taped to the top sides of the inside (movable) boards on the jig. This is done with the least hassle by using small pieces of tape and taping opposite sides while pulling the film tight. After the film is taped all around it's parameter on the jig, the film needs to be cleaned so the epoxy will stick. The film is wiped down on both sides with isopropyl alcohol (91% or 99%) using a small piece of paper towel. Both sides of the diaphragm are then vacuumed off as are both sides of both stator halves.

It is now time to make the diaphragm slightly conductive. This is done by rubbing graphite into the film. First place a stator in the center of a table hollow side up, and carefully place the diaphragm and jig over the stator with the film resting right on top of the stator. Take a roll of masking tape and apply tape to the top of the diaphragm over the parameter rivet area of the stator. The object is to mask off the outer area where the stator are riveted together so no conductive coating is applied there, but there is coating everywhere over the hollow parts of the stators. Carefully lift off the jig and diaphragm after the parameter outline is masked on the diaphragm and then remove the stator. Wipe off the table surface and check to make sure it is smooth with no dirt or other debris that will puncture the diaphragm. If the table has a rough surface a large piece of glass makes an excellent surface to work on. Place the jig back on the table with the film side closest to the table, the tape should be on the top surface.

Apply powdered graphite, which can be purchased from a hardware store as lock lubricant, to a cotton ball and firmly rub the graphite into the film. This

takes a lot of pressure and is real drudgery. The coated area of the diaphragm will turn a darker color and won't easily wipe off if the graphite is being applied with sufficient force. All the area of the diaphragm has to be coated. When the whole area that was masked off has been coated with graphite, vacuum off the whole top surface and surrounding area to remove any stray graphite powder. Any graphite flakes that find their way into a panel is a sure short. It is not necessary, but the excess graphite can be removed by wiping the panel with a paper towel soaked in alcohol. This will raise the resistance of the diaphragm, but care should be taken to not completely scrub all the graphite away. However, in practice it is very difficult to remove all the graphite using alcohol. Then carefully remove the masking tape and vacuum again. There should be a dark square in the center of the clear film on the jig.

The back stator is then placed in the center of a table and a small amount of epoxy is mixed on a card. Five minute epoxy works well once the technique for fixing panels is learned. However it cures too fast to make a first try at panel repairs enjoyable. For the first couple panels, it's a better idea to stick with 30 minute epoxy. Squeeze out about a one inch by 1/8 inch high puddle of epoxy and the same size puddle of hardener on a small card or folded sheet of paper. Mix well with a nail or wooden match stick. Then apply the epoxy on the perimeter edges of the rear stator. It is least messy to only apply epoxy between the rivet holes. This can be seen in figure 4.12. As soon as the parameter has epoxy applied, carefully place the jig on top of the stator so that the film touches the stator. Before lowering the jig carefully line up the coated part of the film so that it is lined up on the stator like it was when it was masked off. Then lower the jig so the film touches the stator. Rub the parameter of the stator with a paper towel to squeeze out the epoxy. Then place the front stator directly over the rear stator like they were assembled. Then pile books or other heavy objects on top of the front stator. Stacks of books at least 6 inches high work well, as seen in figure 4.13. Wait for the epoxy to cure.

When the epoxy has cured, The books or weights can be removed as well as the front stator. The diaphragm can then be heat shrunk using an ordinary hair dryer. Slow sweeping strokes will work well, as seen in figure 4.14.

The rivet holes need to be recut so that the nut and bolt assemblies can be push through to secure the stator halves. However cutting the film can cause it to split (like a candy bar wrapper). It is a much better idea to melt the holes with a soldering iron. This can be seen in figure 4.15.

The bass panel can then be reassembled using 4-40 nuts bolts and washers. The ideal length bolt is a 1/2 inch long pan head philips bolt. A washer on each side and a nut is the perfect length for the bass panels. Each panel requires about 65 bolts. It's easiest to start by bolting through the rivets where the bias supply attaches to the stators, because that is the smallest holes and the hardest to line up. After all the bolts are in place they are tightened down, as shown in figure 4.16.

### Mylar stretching Jig for Quad ESL Panels

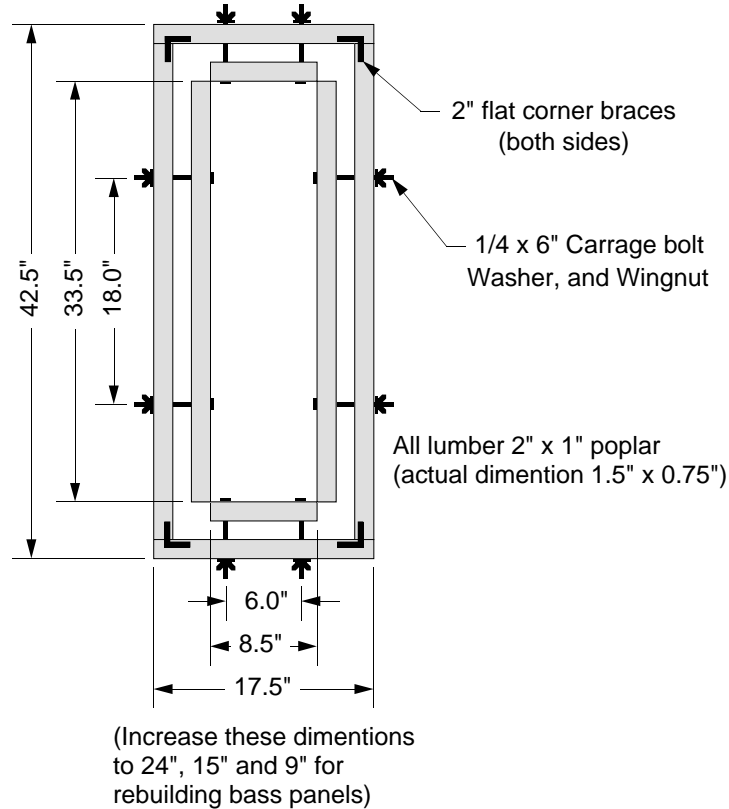


Figure 4.10: Diaphragm Stretching Jig Plans

After all the bolts have been tightened, the panel can be cut away from the rest of the film on the jig. A razor blade works well for this. Cut along the stator edge so no film sticks out. Then place the panel in a dust free place, it is now ready for new dust covers and insulating tape.

The insulating tape that was removed around the parameter of the stator assembly can now be replaced. It is not absolutely necessary to replace this tape especially if care was taken to prevent the conductive coating from being applied to the area where the diaphragm was glued. However it is a good idea to replace the tape just as an extra precaution. Two layers of the thick insulating tape described in the parts and tools chapter works very well. However three or four layers of standard high quality packing tape will also work. Figure 4.17 shows the insulating tape being applied to the parameter of a stator assembly. Figure 4.18 shows a corner of a bass panel with the insulating tape in place.





Figure 4.11: Diaphragm Stretching Jig

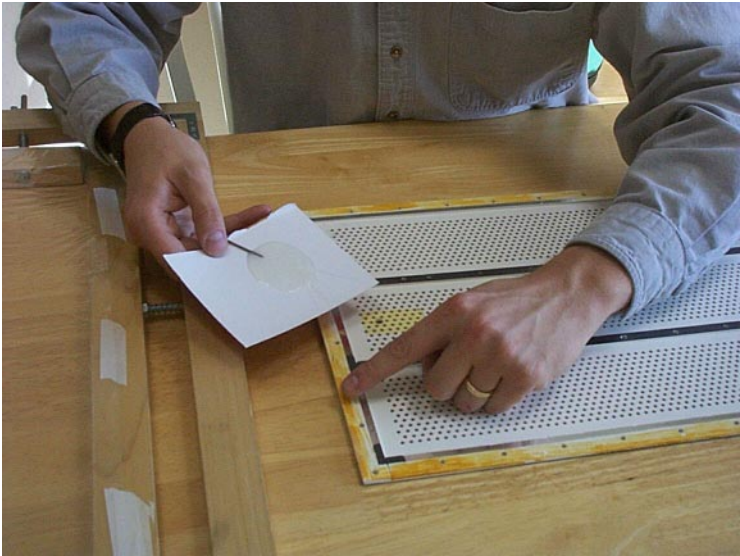


Figure 4.12: Bass Epoxy Application



Figure 4.13: Bass Panel Diaphragm Curing



Figure 4.14: Bass Diaphragm Heat Shrinking



Figure 4.15: Bass Diaphragm Rivet Hole Melting

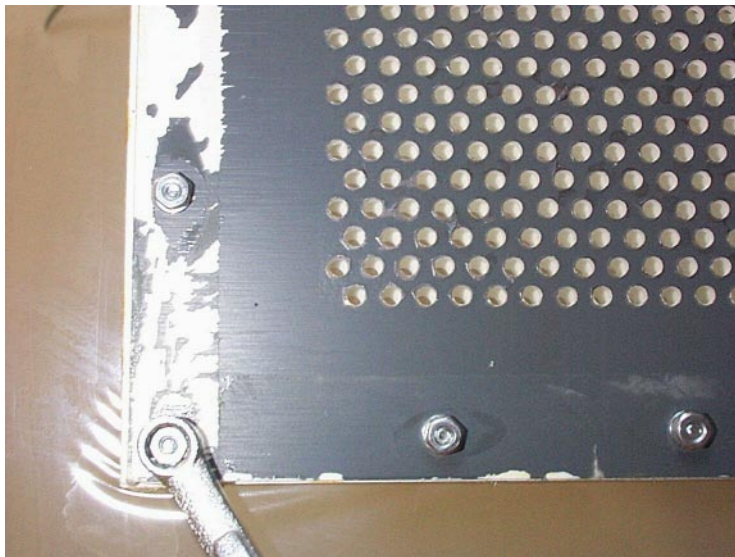


Figure 4.16: Bass Panel Bolt Tightening



Figure 4.17: Bass Panel Insulating Tape Application

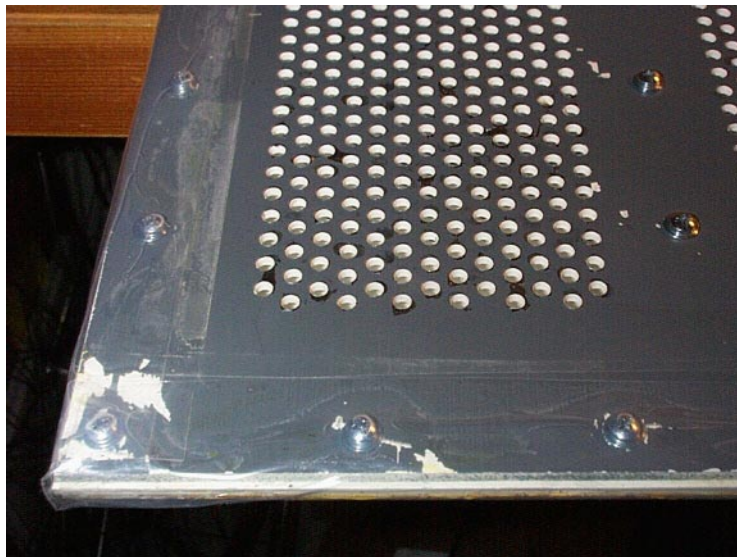


Figure 4.18: Bass Panel Insulating Tape

## 4.4 Dust Cover Replacement

This section is useful as a final step when completely rebuilding panels or if the bass panel is working fine, but the dust cover is split or has holes. The dust covers and the wooden frames should be removed by cutting the parameter tape as described in the panel disassembly section. The wires are then unsoldered as described in the disassembly section.

The original dust cover film is removed by either pulling the tape off the wooden frames, or more cleanly by carefully cutting the film at the edge of the wooden frame as seen in figure 4.19, then removing the old tape. The wooden frames can be washed or wiped down with a damp cloth to remove the years of dust and dirt as well as any powdered tape adhesive residue.

When the frames have dried, they can be recovered with new film. The supplies needed are shown in figure 4.20. These include enough window treatment film to cover the two dust covers, a bottle of ordinary rubber cement or a common contact cement, some masking tape, scissors, and a table large enough to hold the dust covers.

The dust cover film is placed flat on the table and pulled tight using several strips of masking tape around the perimeter of the film. The front face of the dust cover frame is then coated with cement and the dust cover is placed on the film. Books or other weights are added on top of the dust cover frame to hold it firmly against the film (the dust cover frames are warped due to the curvature of the panels when installed in the speakers). After the glue is dry, the edges of the film can be cut away using a pair of scissors. The film should be cut flush with the edge of the dust cover frame. Repeat this process until all the needed dust covers are complete. The dust covers should be vacuumed out to remove any dust and dirt.

The rear dust covers need the terminal strip and wiring installed. A piece of tape is applied to the outside of the back dust cover about the same size as the terminal strip. This piece of tape is applied right under where the terminal strip is attached and reinforces the dust cover film to prevent it from splitting where the wiring passes through the dust cover.

The holes in the dust cover where the terminal strip attaches to the wooden frame need to be melted out using a soldering iron. The terminal strip can then be attached to the wooden frame. Never cut the holes for the wiring, or the film will split, always melt them. Figure 4.21 shows the holes for the wires being melted in the bass dust covers. The terminal strip can be bolted to the frame using the same nut and bolt assemblies used to attach the stators together. The wires are then carefully fed through the dust cover and soldered to the terminal strip again. The rear stator wire is soldered quickly to the electrical tab on the rear stator. The bias wiring harness can then be attached to the stator by attaching the eyelets on the harness to the appropriate nut and bolts on the stator, this can be seen in figure



Figure 4.19: Bass Panel Dust Cover Removal

4.25. The front stator wire is carefully fed through the hole in the stators and quickly soldered to the tab on the front stator.

After the wiring is complete, the dust covers and stators can be re-vacuumed and taped together. Figure 4.22 shows a stator panel being vacuumed. Figure 4.23 shows the dust covers and stator being taped around the parameter. The tape is applied to the top face of a dust cover frame and pulled around the edge of the panel assembly to the other dust cover frame face. The tape should extend a bit past the edge of the panel and wrapped around to the next side and trimmed. The tape from one side should overlap the adjacent side, so the corners have two layers of tape; one from each adjacent side.

After all four sides have been taped, the dust covers can be tensioned using an ordinary hair dryer. This can be seen in figure 4.24. The dust cover should pull tight with no wrinkles. The completed panel can be seen in the closeup of the terminal strip shown in figure 4.25. The panel is now ready to be reinstalled in the speaker frame and rewired to the power supply and input transformer.



Figure 4.20: Bass Panel Dust Cover Supplies



Figure 4.21: Bass Panel Dust Cover Supplies



Figure 4.22: Bass Panel Dust Removal



Figure 4.23: Bass Dust Cover Taping



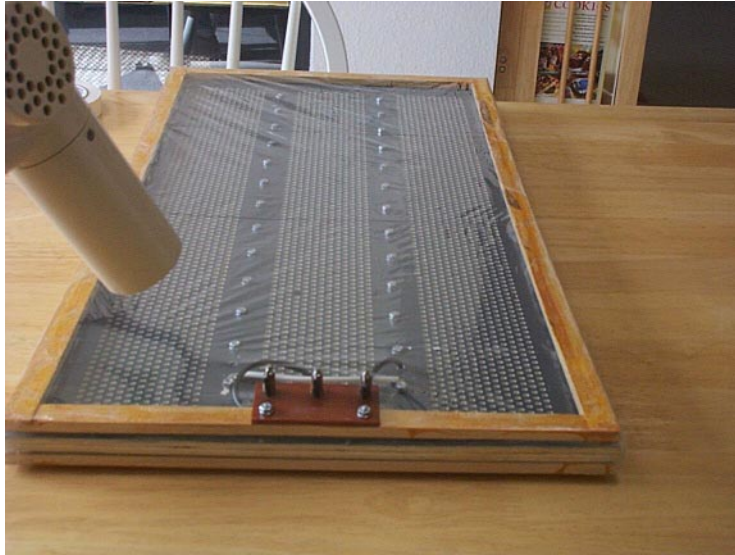


Figure 4.24: Bass Dust Cover Heat Shrinking

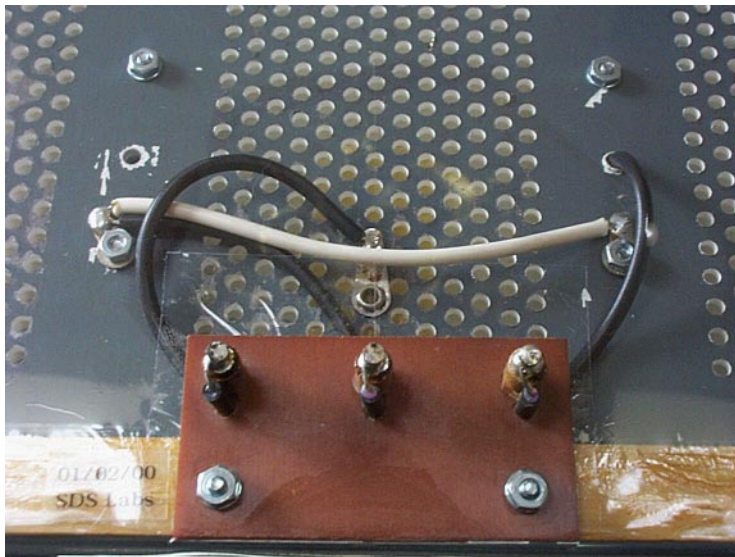


Figure 4.25: Completed Bass Panel Terminal Strip



# Chapter 5

## Treble Panels

### 5.1 Introduction

The Quad ESL treble panels do not suffer from the degradation over time that affects the bass panel diaphragms and dust covers. So, if the treble panel is not over-driven and arced, it's performance should not change over time. However, the treble panels are easily arced when using high powered amplifiers with the Quads. A picture of an arced treble panel is shown in figure 5.1. The Quads were designed during a time when 15 watts of power was a lot. The treble panels arc when the treble panel voltage exceeds about 3300 volts. This corresponds to about 20 watts or so depending on frequency content. Quad changed the crossover network to improve the power handling and reduce the tweeter panel burnout resulting from over-driving when using some of the newer and more powerful Quad transistor amps. When the crossover design change didn't solve the problem, a diode bridge and zener diode clamping circuit was offered as protection for the tweeter. However, many folks believe that this circuit is detrimental to the sound quality. The treble panel is made up of three electrically separate vertical panels each almost 2 inches wide. The two outer sections are driven in parallel, with the center section being driven separately. This is a clever way to improve high frequency dispersion, such that the highest frequencies are only driven by the center section, but the lower frequencies handled by the treble unit are produced by all three sections.

### 5.2 Disassembly

The Quad ESL treble panels are disassembled similarly to the bass panels. After removing the treble panel from the ESL frame (see disassembly chapter), the rear felt damping pad can be removed. The vast majority of the ESL's have the felt pads stapled to wooden strips that run vertically down each side of the treble unit.

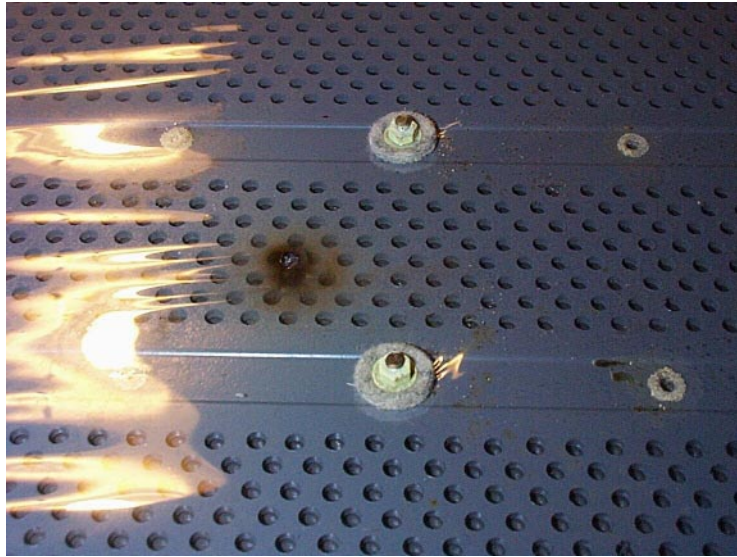


Figure 5.1: An Obvious Treble Panel Burn

The felt pad is stapled to the rear of the treble unit through the wooden strips. These can be removed by carefully prying the wooden strip away from the dust cover frame on the back of the treble panel. Figure 5.2 shows the bottom of the felt pad being pulled away from the rear of the treble panel.

The dust cover is prevented from vibrating and rattling by four tensioning points. These tensioning points are nut and bolt assemblies with protective felt washers that clamp the dust cover to the stators. These bolt assemblies prevent the dust covers from being removed, and should be removed prior to removing the dust covers. The removal of the bolts and felt washer assemblies is shown in figure 5.3.

After the felt washers are removed, the dust covers can be cut away from the perimeter tape, this is shown in figure 5.4. Unlike the bass panels, there is no terminal strip for the electrical connections, so the dust covers remove easily from each side of the treble panel. The stator assembly is then exposed and the insulating tape can then be removed. The tape removal is shown in figure 5.5.

The high voltage polarizing or bias supply connection is via two bolts which clamp two eyelets to rivets which are connected internally to the panel. These two nut and bolt assemblies must be removed before the two stators can be separated. This is shown in figure 5.6.

To separate the two stator halves, the sixty or so rivets must be removed. This is most easily done by carefully drilling them out. A  $9/64$  inch drill bit works very well to drill out the rivets. A small drill press makes drilling out the rivets relatively painless, although a hand drill will work as well. Figure 5.7 shows a rivet being drilled out in a drill press. Care must be taken, particularly with the

corner rivets, that the stators are not cracked by exerting too much force when drilling out the rivets.

At this point, the two stators can be carefully pulled apart to expose the old diaphragm. If the panel has been arced, it should be fairly obvious. A treble panel arc is shown in figure 5.8. Not only does an arc destroy the diaphragm, it frequently has enough energy to damage the stators in the area of the arc. The failure mode after an arc is that the ragged hole in the diaphragm comes in contact with one of the stators and thus shorts out the diaphragm not allowing it to charge. When the arc is severe enough to melt the stators, the carbonized and melted stator will frequently come in contact with the diaphragm or even the other stator, thus shorting the diaphragm to the stator and even one stator to the other. The diaphragm is most easily removed by taping the perimeter of the diaphragm with masking tape. Then the tape is carefully lifted off, and the diaphragm should pull away from the rear stator. This is shown in figure 5.9

The majority of arcs in treble panels are fairly small, in the order of 1/4 inch or less in diameter. These require little panel repairs. The carbonized burned plastic is carefully scraped away with an Exacto knife. The bare plastic and conductive paint can be covered with a little red glyptol or corona dope (see supplies section), but is not necessary.

If the burn is large or the panel has arced at the connecting rivet, the conductive paint may have to be repaired. This is particularly damaging if the panel arcs at the rivet, which can easily cause the conductive paint around the rivet to be burned away breaking the contact from the rivet to the rest of the stator. A highly conductive paint is available for fixing circuit board traces, and works well to repair the stators (see supplies section). If this material is difficult to obtain, auto parts stores sell a conductive paint designed to repair the resistive heating elements used as rear window defrosters in modern automobiles. Figure 5.10 shows the silver repair paint around a burn which occurred at the rivet junction. The stator is tested by measuring the resistance from the terminal on the outside of the stator to the conductive coating on the inside of the stator around the perforated holes. The easiest way to measure the resistance is to clip one of the ohmmeter leads onto the solder tab on the outside of the stator. Push or gently scrape the grey paint around a stator hole on the inside of the stator until the meter shows a non-infinite resistance. It's easiest to learn the technique on a non damaged stator section. A healthy painted stator should measure in the 8-10 kohm range. But this value does vary depending on the thickness of the conductive coating. The conductive coating covers the perforated area, and stops about 1/4 inch away from the edges of each vertical cell.

The smaller holes do not need to be repaired as a general rule, as long as the conductive coating on the inside is still largely intact. Even holes as large as 1/2 inch in a stator can be considered small when considering the whole driven area verses the damaged area.

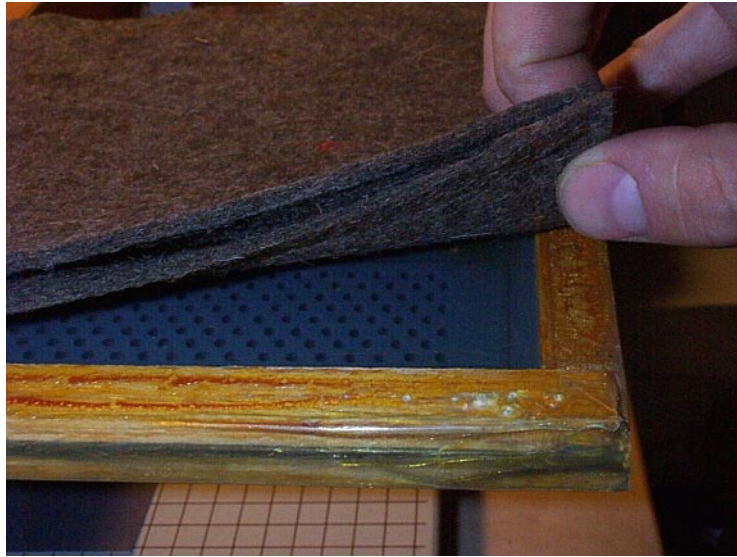


Figure 5.2: Removing The Rear Felt Pad

When learning the rebuilding technique, it's not uncommon to have to rebuild a panel several times. Heat shrinking the diaphragm requires a careful technique and too much heat will melt a hole in the diaphragm. The tweeter panels may need to be rebuilt decades from now as well. So being able to remove the epoxy prior to another rebuild is an important part of a panel rebuild. However it is not necessary to remove any material for the first rebuild, thus if the panels being worked on have never been rebuilt, this part isn't necessary. The epoxy can be removed via chemical means using acetone, but the stators are plastic and too much exposure to acetone will soften them. The easiest way to remove the old epoxy is to use a Dremel moto tool and a drum sanding attachment. The epoxy can be easily removed using light pressure and moving back and forth to prevent too much heat build up. Figure 5.11 shows the epoxy being removed from a previously rebuilt panel. Figure 5.12 shows the resulting panel after the epoxy is removed. The epoxy sands off as white flakes and powder, the stator material is a black plastic, so it's easy to see when the epoxy has been removed down to the stator material. The stators are now ready to be rebuilt.



Figure 5.3: Removing The Dust Cover Retaining Screw Assemblies



Figure 5.4: Removing The Dust Cover



Figure 5.5: Removing The Insulating Tape

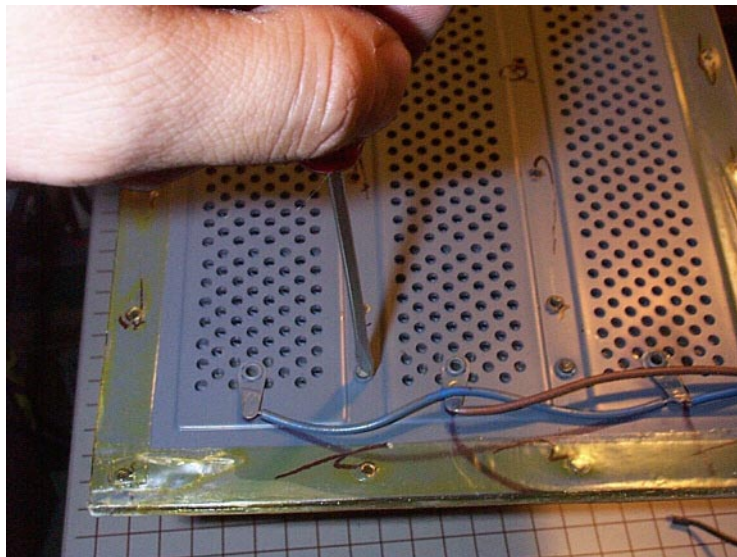


Figure 5.6: Removing The Bias Wire Retaining Screws



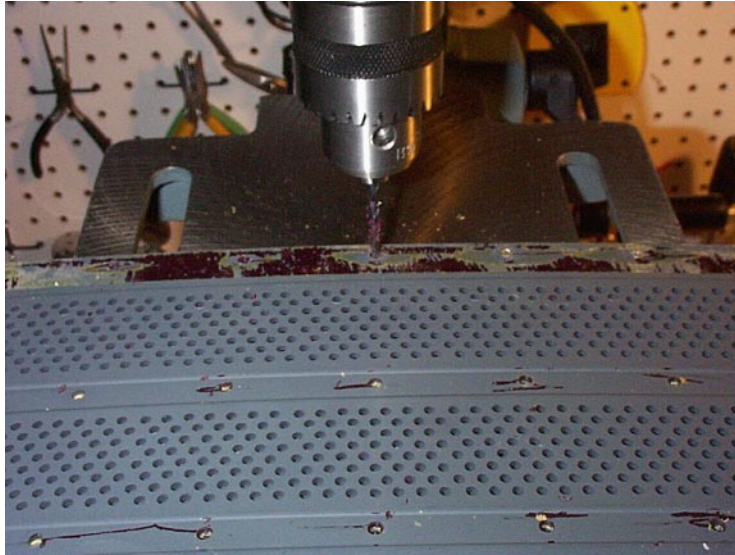


Figure 5.7: Drilling Treble Panel Rivets

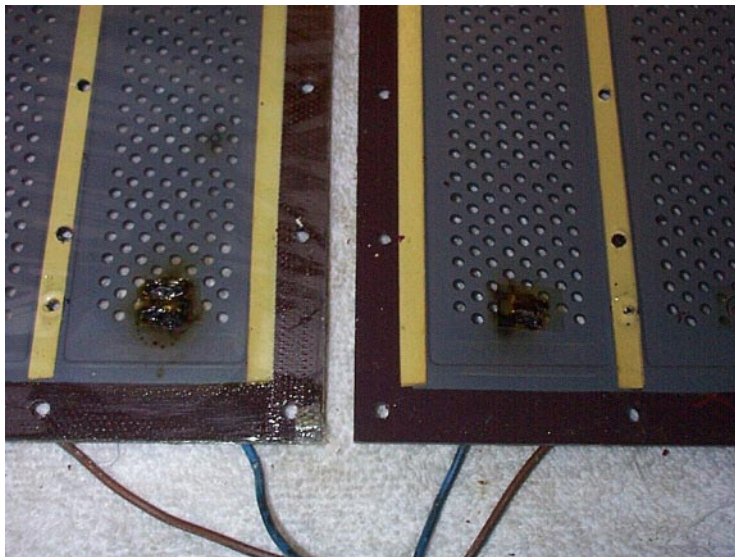


Figure 5.8: Treble Panel Burn

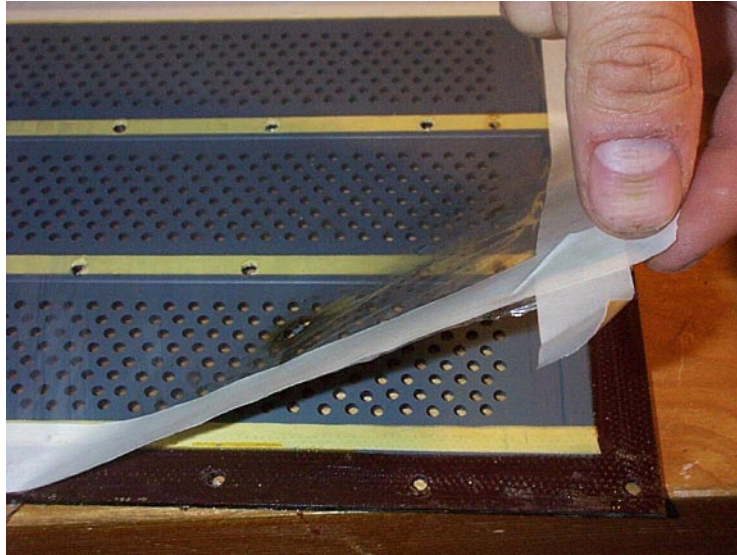


Figure 5.9: Removing The Old Treble Panel Diaphragm



Figure 5.10: Conductive Paint Repair



Figure 5.11: Grinding Epoxy On Previously Rebuilt Panel

### 5.3 Diaphragm Replacement

The diaphragm can now be replaced, this is done in a very similar manner as the bass panel diaphragms. Figure 5.13 shows the stretching jig, stators and a piece of mylar. The mylar is taped to the inner portions of the stretching jig such that it is free of wrinkles. This is most easily done by positioning the mylar then taping opposite sides while pulling it taught with the tape. Figure 5.14 shows a piece of mylar taped to the stretching jig. It is not necessary to draw the mylar tight with the stretching jig if the diaphragm is to be heat shrunk. Heat shrinking tends to result in diaphragms of more uniform and consistent tension than using the stretching jig. But satisfactory results can be obtained with the stretching jig.

It is now time to make the diaphragm slightly conductive. This is done by rubbing graphite into the film. First place a stator in the center of a table hollow side up, and carefully place the diaphragm and jig over the stator with the film resting right on top of the stator. Take a roll of masking tape and apply tape to the top of the diaphragm over the parameter rivet area of the stator. The object is to mask off the outer area where the stator are riveted together so no conductive coating is applied there, but there is coating everywhere over the hollow parts of the stators. Carefully lift off the jig and diaphragm after the parameter outline is masked on the diaphragm and then remove the stator. Wipe off the table surface and check to make sure it is smooth with no dirt or other debris that will puncture the diaphragm. If the table has a rough surface a large piece of glass makes an excellent surface to work on. Place the jig back on the table with the film side closest to the table, the tape should be on the top surface.

Apply powdered graphite, which can be purchased from a hardware store as



Figure 5.12: Treble Panel With Previous Epoxy Ground Off

lock lubricant, to a cotton ball and firmly rub the graphite into the film. This takes a lot of pressure and is real drudgery. The coated area of the diaphragm will turn a darker color and won't easily wipe off if the graphite is being applied with sufficient force. All the area of the diaphragm has to be coated. When the whole area that was masked off has been coated with graphite, vacuum off the whole top surface and surrounding area to remove any stray graphite powder. Any graphite flakes that find their way into a panel is a sure short. It is not necessary, but the excess graphite can be removed by wiping the panel with a paper towel soaked in alcohol. This will raise the resistance of the diaphragm, but care should be taken to not completely scrub all the graphite away. However, in practice it is very difficult to remove all the graphite using alcohol. Then carefully remove the masking tape and vacuum again. There should be a dark square in the center of the clear film on the jig.

The back stator is then placed in the center of a table and a small amount of epoxy is mixed on a card. Five minute epoxy works well once the technique for fixing panels is learned. However it cures too fast to make a first try at panel repairs enjoyable. For the first couple panels, it's a better idea to stick with 30 minute epoxy. Squeeze out about a one inch by 1/8 inch high puddle of epoxy and the same size puddle of hardener on a small card or folded sheet of paper. Mix well with a nail or wooden match stick. Then apply the epoxy on the parameter edges of the rare stator. It is least messy to only apply epoxy between the rivet holes. This can be seen in figure 5.16. As soon as the epoxy has been applied to the perimeter of the stator, carefully place the jig on top of the stator so that the film touches the stator. Before lowering the jig carefully line up the coated part

of the film so that it is lined up on the stator like it was when it was masked off. Then lower the jig so the film touches the stator. Rub the perimeter of the stator with a paper towel to squeeze out the epoxy, as shown in figure 5.17. Then place the front stator directly over the rear stator like they were assembled. Then pile books or other heavy objects on top of the front stator. Stacks of books at least 6 inches high work well, as seen in figure 5.18. Wait for the epoxy to cure.

When the epoxy has cured, The books or weights can be removed as well as the front stator. The diaphragm can then be heat shrunk using a heat gun. Heat guns can be purchased at electronics stores to heat shrink tubing, they can also be purchased at hardware stores for stripping paint. A larger rather than smaller heat gun seems to work best. The shrinking technique is a little tricky and should be practiced on a piece of mylar taped to the stretching jig before trying to shrink an epoxied diaphragm. If the heat gun is too close and or moving too slowly, the diaphragm will overheat and melt. Too little heat and it won't shrink. A back and forth motion across the short side of the stator moving smoothly past the stator on each side tends to work well. The heat shrinking of a treble panel is shown in figure 5.19.

There are other "wipe-on" coatings that can be used in place of the graphite rubbing technique. Shown in figure 5.20 is an Indium Tin Oxide polyester resin coating being applied to the treble diaphragm after heat shrinking. The advantages of graphite is that it will not evaporate over time like many wipe on coatings will, including the original Quad ESL coatings. The advantage of wipe-on coatings is that they are much less work than graphite and can be made to be higher resistance than graphite. However the higher resistance doesn't effect the sound quality of the speaker. If wipe-on coatings are used, the graphite rubbing step described above can be eliminated and the coating is applied after heat shrinking. However, the graphite technique is straightforward and difficult to do incorrectly, the wipe-on coatings can be tricky to apply properly and can wear off.

The rivet holes need to be recut so that the nut and bolt assemblies can be push through to secure the stator halves. As with the bass panels, the rivet holes should be melted using a cheap soldering iron. If the holes are cut rather than melted, the diaphragm will likely split.

The panel can then be reassembled using 4-40 nuts bolts and washers. The ideal length bolt is a 3/8 inch long pan head philips bolt. A washer on each side and a nut is the perfect length for the treble panels. Each panel requires about 65 bolts. It's easiest to start by bolting through the rivets where the bias supply attaches to the stators, because that is the smallest holes and the hardest to line up, these two bolts can be used without washers as well. Figure 5.21 shows the bolts being installed in a treble panel.

After all the bolts have been tightened, the panel can be cut away from the rest of the film on the jig. A razor blade works well for this. Cut along the stator edge so no film sticks out. The panel can now be tested before installing the dust



Figure 5.13: Panel Repaired And Ready To Rebuild

covers, this is shown in figure 5.22. Great care should be taken when testing a panel as shown. The audio transformer can produce lethal shocks and should not be touched while in operation. A function generator is useful for producing the audio input signals.

The insulating tape that was removed around the perimeter of the stator assembly can now be replaced. It is not absolutely necessary to replace this tape especially if care was taken to prevent the conductive coating from being applied to the area where the diaphragm was glued. However it is a good idea to replace the tape just as an extra precaution. A layer of the thick insulating tape described in the parts and tools chapter works very well. However three or four layers of standard high quality packing tape will also work.

## 5.4 Dust Cover Replacement

Unlike the bass panels, treble panel dust covers rarely need to be replaced unless the panel is being rebuilt. The treble panel dust cover is mylar and does not become brittle like the saran bass panel dust cover.

The original dust cover film is removed by either pulling the tape off the wooden frames, or more cleanly by carefully cutting the film at the edge of the wooden frame as seen in figure 4.19 in the bass panel rebuilding section, then removing the old tape. The wooden frames can be washed or wiped down with a damp cloth to remove the years of dust and dirt as well as any powdered tape adhesive residue.

When the frames have dried, they can be recovered with new film. The sup-



Figure 5.14: Mylar Diaphragm Taped To Stretching Jig



Figure 5.15: Vacuuming Panels And Mylar Diaphragm



Figure 5.16: Application of Treble Panel Epoxy



Figure 5.17: Smoothing Treble Panel Epoxy





Figure 5.18: Weighting Panel While Epoxy Cures



Figure 5.19: Heat Shrinking Treble Panel



Figure 5.20: Applying ITO Coating To Treble Panel



Figure 5.21: Bolting Treble Panel Together with  $3/8''$  4 – 40 Bolt Assemblies

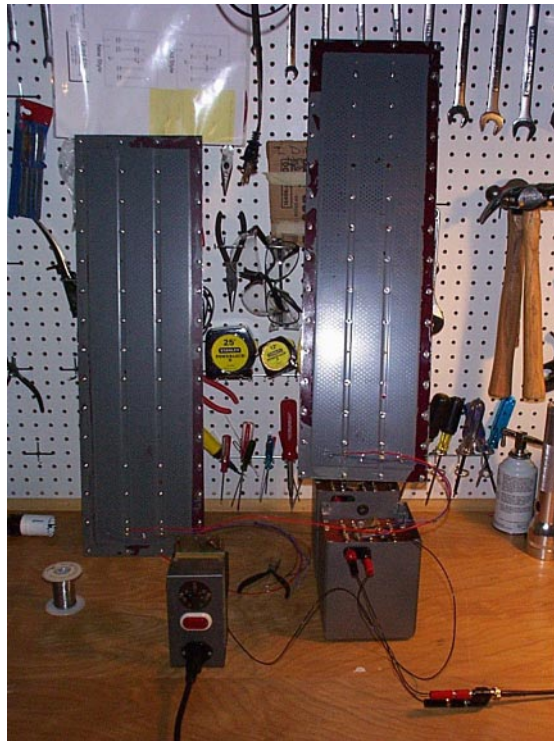


Figure 5.22: Testing Treble Panel

plies needed are shown in figure 5.23. These include enough mylar film to cover the two dust covers, a bottle of ordinary rubber cement or a common contact cement, some masking tape, scissors, and a table large enough to hold the dust covers.

The dust cover film is placed flat on the table and pulled tight using several strips of masking tape around the parameter of the film. The front face of the dust cover frame is then coated with cement and the dust cover is placed on the film. books or other weights are added on top of the dust cover frame to hold it firmly against the film (the dust cover frames are warped due to the curvature of the panels when installed in the speakers). After the glue is dry, the edges of the film can be cut away using a pair of scissors. The film should be cut flush with the edge of the dust cover frame. Repeat this process until all the needed dust covers are complete. The dust covers should be vacuumed out to remove any dust and dirt.

The dust covers and stators can now be re-vacuumed and taped together. The treble panels are taped in a similar fashion to the bass panels, as see in Figure 4.23. The tape is applied to the top face of a dust cover frame and pulled around the edge of the panel assembly to the other dust cover frame face. The tape should extend a bit past the edge of the panel and wrapped around to the next side and trimmed. The tape from one side should overlap the adjacent side, so the corners



Figure 5.23: Treble Panel Dust Cover Ready To Be Rebuilt

have two layers of tape; one from each adjacent side.

After all four sides have been taped, the dust covers can be tensioned using the heat gun. The heat shrinking process is the same as the diaphragm tensioning, and thus requires careful application of heat to prevent a hole from being melted in the dust cover. The dust cover should pull tight with no wrinkles. The completed panel can be seen in figure 5.25. The panels are now ready to be reinstalled in the speaker frames and rewired to the power supply and input transformer.

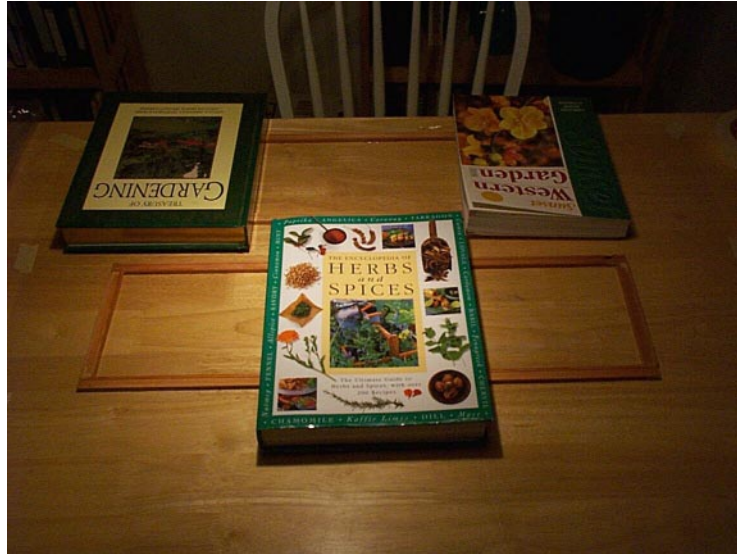


Figure 5.24: Treble Panel Dust Covers Glued To Frames



Figure 5.25: Finished Treble Panels



# Chapter 6

## Power Supply

### 6.1 Introduction

The Quad ESL power supply is typically problem when a Quad ESL that has never been abused loses efficiency. This is manifested as one speaker becoming less loud over time when compared to the other. This is caused by the rectifier diodes in the rectifier block becoming leaky and not producing enough bias voltage.

The power indicator lights on the back of the power supplies are often burned out or blinking. The neon bulbs in the lamp assembly can be replaced, but the lamps are not critical to the operation of the speakers.

The input connectors were manufactured by Bulgin and are no longer available. Spare connectors can be found, but they are getting scarce. The bulgin connectors can be replaced with more modern IEC connectors if desired.

The power supply schematic is shown in figure 2.2 or figure 2.3. The two schematics show the old and new style Quad ESL's, however the power supplies are the same between each style.

### 6.2 EHT Block Rebuilding

The vast majority of all Quads sold use the newer style EHT modules that consist of a phenolic or plastic box which is open at the top. The EHT circuit board is sticking out of the top of the box. The box is filled with bee's wax which covers all the traces and components on the circuit board. This type of module can easily be rebuilt. The most early Quad ESL's have an epoxy block that houses the EHT components. This block cannot be easily rebuilt. A circuit board has been designed to replace this epoxy EHT block, but will work in place of the newer blocks as well. The circuit board and schematic is shown in figure 6.1.

The EHT modules can be tested using a commercial high voltage probe, or a high voltage probe can be constructed simply using a pair of 750 megohm resistors

available from digikey. The two 750megohm resistors are placed in series making one 1500 megohm resistor, and this resistor is used with a multimeter's internal 10 megohm resistance to form a voltage divider. The negative terminal of the multimeter is attached to the frame of the power supply. The positive test lead is clipped to one end of the two series resistors and the other end of the resistors is touched to the 1500 volt tap and the 6 kV tap. The meter would be set on DC volts and should read about 10 volts for the 1500 volt tap and about 35 volts for the 6 kV tap. The reason the 6 kV tap doesn't read 40 volts is that the high voltage probe loads the supply down. **WARNING:** The high voltage supply isn't very powerful, but can still give a nasty shock. Treat it with respect and obey good testing practices.

The EHT block assembly is located at the top rear portion of the power supply, it is shown in figure 6.2. First the two wires from the transformer must be unsoldered to free the block from the rest of the power supply, this is shown in figure 6.3. The EHT blocks are held in place by two screws which must be removed, as shown in figure 6.4. After the EHT module is removed from the power supply, the two screws should be reinstalled in the EHT box to prevent wax leakage during the rebuilding process, see figure 6.5

The circuit boards in the EHT blocks can now be removed by gently melting the wax. A pie plate or a Pyrex measuring bowl works well to hold the wax. A convenient method to melt the wax is to place the EHT modules in a container and place the container in the oven set at about 300 - 325 degrees F. It will take about 30 - 60 minutes to melt the wax within the boxes, do not turn up the heat to speed up the process, the wax has a low flashpoint. After all the wax has melted, the circuit boards can be removed from the boxes.

Figure 6.7 shows the circuit boards removed from the wax and boxes and ready to rebuild. The EHT circuit consists of a pair of voltage adjusting resistors, a string of diodes and capacitors wired as a Cockroft-Walton multiplier. Occasionally the carbon voltage setting resistors will drift and the voltage will be slightly off compared to the other EHT. The ceramic capacitors rarely ever go bad. The diodes are the typically in need of a replacement.

There are two styles of the modern EHT circuit boards. The earlier version uses 16 diodes set up as 8 series pairs. The newer design uses only 8 high voltage diodes. These two board versions are shown in figure 6.8. After rebuilding many EHT modules, it appears that the 8 diode modules go bad more frequently than the older 16 diode versions. New high voltage diode can be used, but are much more expensive than the common 1N4007 1000 volt diode. The high voltage diodes used by Quad are model number GP02-30. The most cost effective solution to replacing the EHT diodes is to remove the 8 or 16 diodes and replace them with 16 1N4007 diodes. One EHT should be worked on at a time, and the other used as a guide to insure that the diodes are installed correctly. The completed boards should look like figure 6.9. After the circuit boards are rebuilt, they can be placed



back into the boxes and the potting wax poured back into the boxes. After the boxes have cooled, they can be reinstalled in the power supplies, and the two transformer wires reattached. Extra bee's wax can be purchased from craft stores or candle making shops. However, the wax doesn't need to completely cover the caps, as long as the diodes and cap leads are covered.

## 6.3 Lamp Rebuild

The Quad power supplies have neon lamps to indicate that the speakers are powered up. These lamps are connected directly to the mains wires and do not effect the operation of the speaker. However when doing a thorough rebuild, it's a nice touch to have the lamps working again. The neon lamps consist of a translucent red front cover that houses the neon lamp and dropping resistor. When the front cover is removed and the rear wires unsoldered, the terminals and lamp assembly can be removed.

Before the lamp assembly can be removed, the rear wires must be removed, figure 6.10. The lamp assembly can then be pushed out of the power supply frame if desired, although the power supply frame holds the lamp assembly and can make reassembly easier.

The rivets holding the front cover have a slight twist to them. One way of removing them is to use a fine pair of diagonal cutters to grasp the head of the rivet. The rivet is removed with a counter-clockwise pulling motion, as shown in figure 6.11.

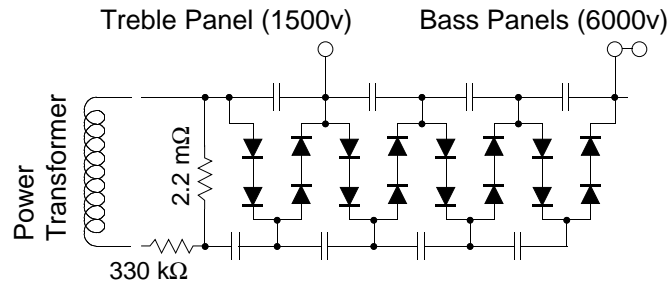
The parts of the lamp assembly are shown in figure 6.12. One neon lamp lead is spot welded to one of the terminals that protrude from the back of the lamp assembly. The other neon lead is twisted to one lead of the dropping resistor. The other lead of the dropping resistor is spot welded to the other terminal. The neon lamp is replaced with a new NE-2 bulb or one of the NE-2 variants. The dropping resistor value is determined from the data sheet for the particular neon bulb chosen. A 1/4 watt resistor is sufficient for this use. The lamps and resistor is replaced in the same orientation as the old lamp and resistor. The leads are soldered to the terminals rather than spot welded.

The terminals and lamp assembly are carefully pushed back into the lamp housing. The red lamp cover is put in place, and the two rivets are carefully pushed back into place. The power supply leads are then re-soldered to the lamp assembly.

## 6.4 Bulgin Replace

The original Bulgin connectors work well and look good, but like all phenolic parts, are brittle and can easily be broken, as seen in figure 6.13. The Quad ESL's

## EHT Block Circuit and Replacement Board



All Diodes: 1N4007  
All Capacitors: 0.01  $\mu$ F 2 kV

## Notes:

When bolting circuit board to power supply frame, use 1/4" stand-offs to insure that the traces are far enough away from the metal frame to prevent arcing.

Coating the circuit board with corona dope or conformal coating is recommended to prevent corona. In a pinch, a good coating of bee's wax will also work.

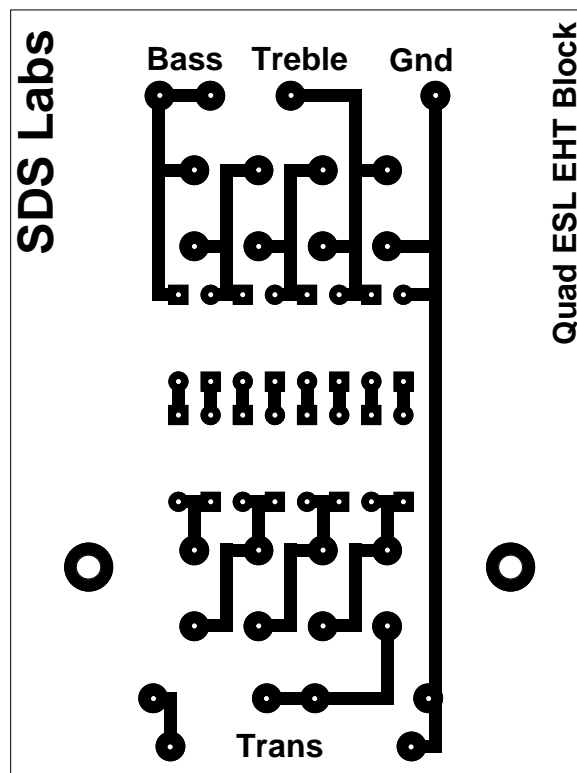


Figure 6.1: New EHT Module Circuit Board



Figure 6.2: Quad ESL Power Supply

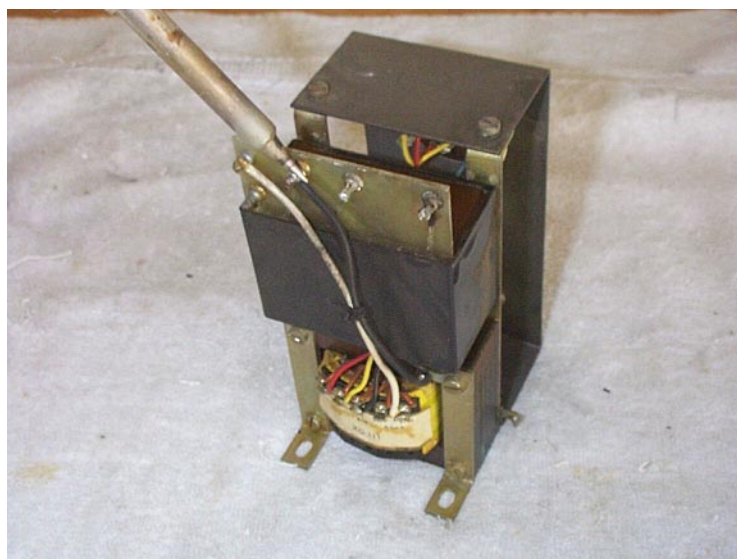


Figure 6.3: Unsolder EHT Block

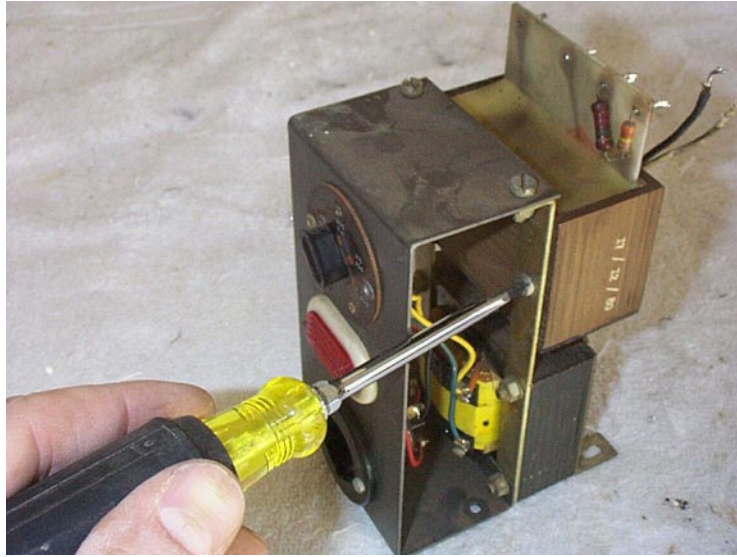


Figure 6.4: Unscrew EHT Block



Figure 6.5: Replace EHT Screws



Figure 6.6: Wax Ready To Be Melted



Figure 6.7: EHT Boards Removed From Melted Wax



Figure 6.8: Cooled Boards Ready To Rebuild

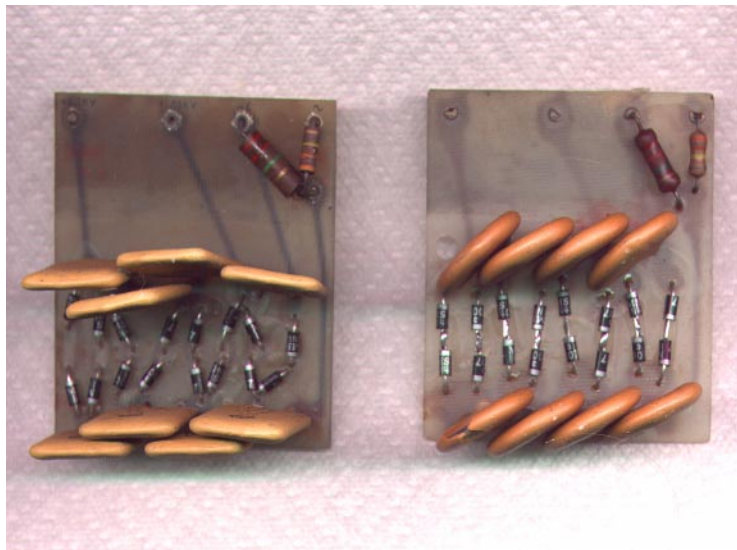


Figure 6.9: EHT Boards With New Diodes

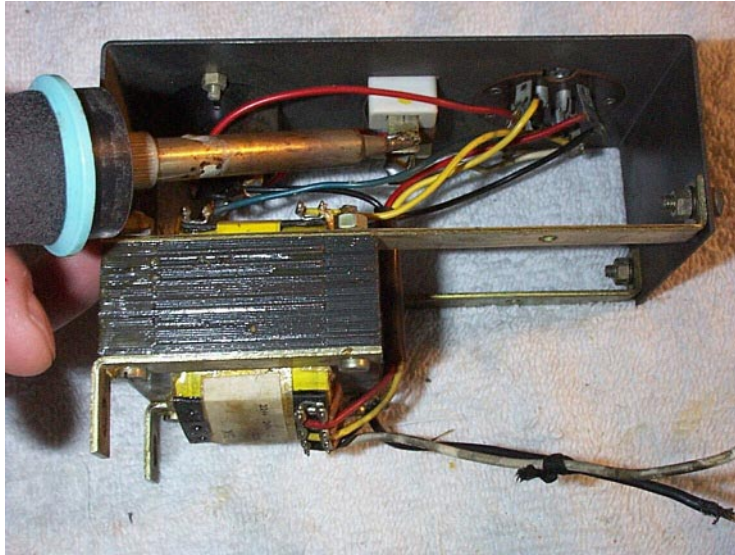


Figure 6.10: Unsolder Neon Bulb Leads



Figure 6.11: Carefully Removing Neon Bulb Cover Retaining Rivets

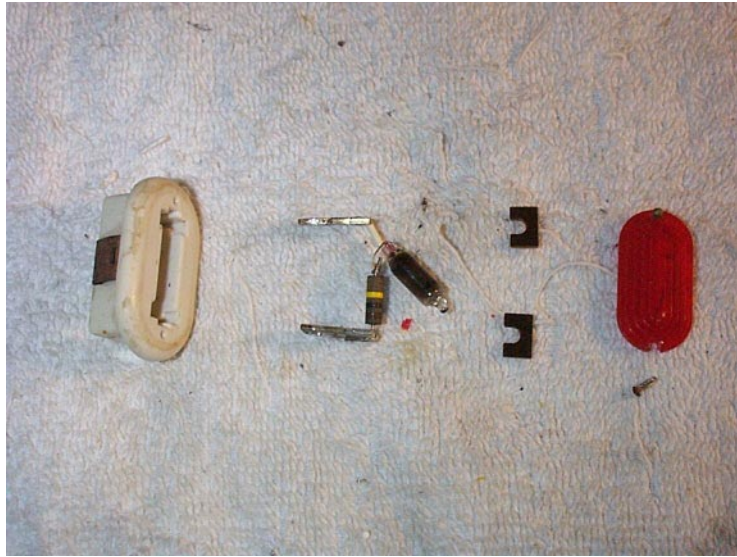


Figure 6.12: Neon Lamp Parts

are often sold without the plugs. The need to replace the connectors stems more from the inability to find replacements rather than any shortcoming on the part of the connector.

The connectors can be replaced with IEC connectors, but the IEC connector is square and the old bulgin connector is round. This is shown in figure 6.14. This is the classic dilemma, of trying to fit a square peg in a round hole. To accommodate an IEC connector, the round hole must be ground out a little, this is shown in figure 6.15. When the connector is installed, the finished power supply looks quite good, as seen in figure 6.16.

There is another possible replacement for the bulgin connector, it's called a Power-On connector by Neutrik. It should be basically a drop in replacement for the bulgin connector.





Figure 6.13: Unscrew Broken Bulgin Connector



Figure 6.14: Bulgin and IEC Connectors



Figure 6.15: Grinding Round Hole For A Square Plug



Figure 6.16: Installed IEC connector

# Chapter 7

## Input Transformer

The Quad input transformer is an essentially trouble free portion of the speakers. The audio input jacks are a weak point in this component. They are very cheap quality banana connectors with plastic bodies and threads. Most of the ESL's have loose banana connectors, and if they have been handled badly, the connectors can be broken.

The plastic input jacks can be easily replaced with higher quality modern equivalents. The input wiring must be unsoldered, as seen in figure 7.1. Then the old jacks can be unbolted, as seen in figure 7.2, and new banana jacks can be bolted in place. The input wiring is then re-soldered to the new jacks.

Many folks find the narrower than usual banana jacks to be a problem when attaching speaker cables to the speakers. More modern 5 way binding posts can be added to the input transformer by grinding out the banana jack holes slightly as seen in figure 7.3. Note that a piece of paper towel has been carefully taped in place to prevent metal shavings from falling into the crossover and transformer portions of the case.

If the treble panels have been arced, there is a chance that the crossover components in the input transformer assembly have been damaged. The resistors should be checked with an ohm meter and compared to the schematic as shown in figure 2.2 and figure 2.3. The capacitors in the crossover rarely go bad, and the resistors only occasionally are damaged by arcing.

To prevent future treble panel arcing, a protection device can be added to the input transformer. Quad produced a diode bridge and zener diode clamping circuit to protect the tweeter. However their circuit effects the sound of the speaker. A better modern alternative is to use a gas discharge tube. It works much like a spark plug to arc at a lower voltage than the treble panel arcing point. When the gas discharge tube is not arcing, it has a very large resistance and a very small capacitance, so it doesn't effect the sound of the speaker at all. The original quad circuit and the gas discharge tube are shown in the add-on's chapter, figure 9.9. The treble panel arcs over around the 3 kV to 3.3 kV point depending on man-

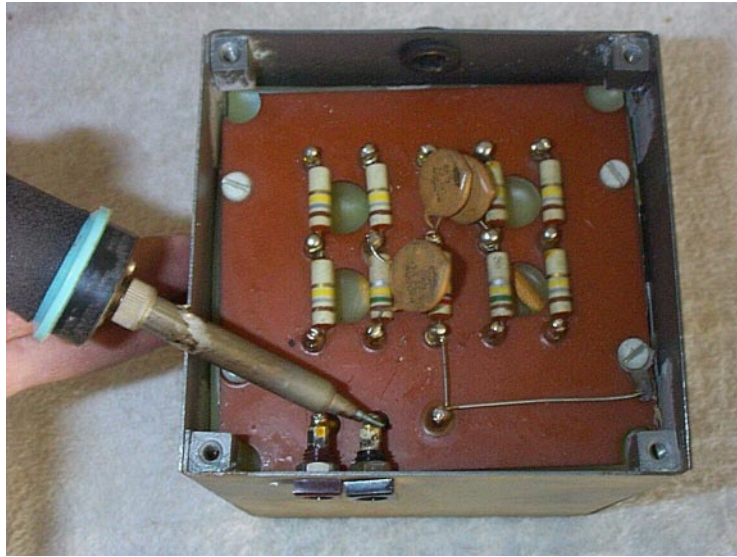


Figure 7.1: Unsolder Audio Input Jacks

ufacturing tolerances. So a discharge tube that arcs at a low voltage will protect the tweeters. One model of gas discharge tube that works well is made by "CP Clare" and is model number CG3-1.5L. It looks like a fat ceramic resistor that is soldered in place under the input transformer. It is connected electrically to the tweeter secondary winding on the input transformer. It connects to pins 9 and 7 on the new style input transformer, as shown in figure 2.2. Or it is connected to pins 7 and 6 on the old style input transformer as shown in figure 2.3.

Figure 7.4 shows a completed new style input transformer with the original banana jacks replaced with a modern five-way binding post. A CP Clare Gas discharge tube has also been added for tweeter protection.

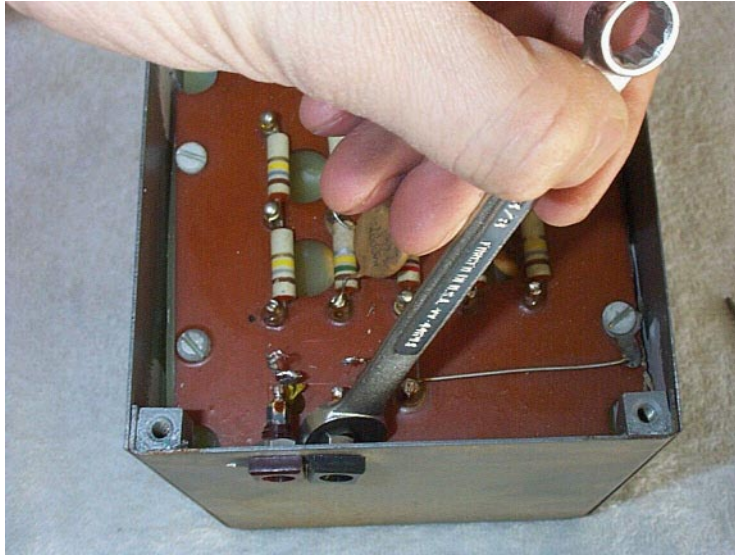


Figure 7.2: Unbolt Audio Input Jacks



Figure 7.3: Grind Input Jack Holes For A 5-Way Binding Post



Figure 7.4: Finished Input Transformer (With Gas Discharge Tube)

# Chapter 8

## Wiring & Reassembly

Reassembly of the Quad ESL requires reversing the steps taken to disassemble the speaker. However, extreme care should be taken to not puncture the fragile dust covers. The vertical treble panel support members in the frames have 4 metal pins that pierce the rear treble panel dust cover frame, and are an extreme hazard to the treble panel dust covers. The pins help to hold the treble panel in place. Soldering the bass panel wiring and power supply connections must be performed with caution to avoid accidental bass panel dust cover damage.

### Panel Installation

The treble panel is carefully placed against the frame's vertical treble panel supports. Do not press the treble panel into the pins protruding from the front of the supports yet. Figure 8.1 shows the treble panel placed in a cleaned and painted wooden frame. Another set of hands to hold the treble panel while installing the first bass panel can be helpful.

Figure 8.2 shows the first bass panel set in the frame. The bass panel has to be carefully slid behind a set of brackets mounted at top and bottom of the frame. The panel is slid into place by placing the bass panel so it overlaps the treble panel with the bass panel's outside edge tucked behind the retaining brackets at top and bottom of the frame. Extreme care should be taken to insure that the terminal strip at the bottom of the bass panel does not puncture the treble panel dust cover. The bass panel is then pushed toward the outside of the frame. The second bass panel is installed using the same technique, and is shown in figure 8.3.

The bass panels must now be pushed over the lip on the edges of the frame. This requires that the bass panel be pushed forward from the back. This is best done, by pushing forward on the rear dust cover frame with one hand while pushing the panel to the outside of the frame with the other hand. The rebuild bass panels are slightly thicker due to the protrusions of the nut and bolt assemblies used to reattach the stator panels. This can make pushing the bass panels over the



Figure 8.1: Treble Panel Installed In Frame

outer lip a bit of a struggle. Care must be taken not to puncture the dust cover when performing this final installation step. Figure 8.4 shows both bass panels pushed into place.

After the two bass panels are firmly seated in place, the treble panel can be centered between the two bass panels. This is done by pushing the center of the treble panel forward from the rear center, so that it no longer contacts the four retaining pins on the vertical supports. The panel can then be moved back and forth to center it between the bass panels. After centered, the panel can be pushed onto the four retaining pins. This is done by pressing on the front center of the bass panel dust cover frames which are resting against the treble panel dust cover frame.

The aluminum retaining brackets can now be screwed in place as seen in figures 8.5 and 8.6. These brackets hold the panels firmly in place, preventing the bass panels from slipping off the side rails and also preventing the treble panel from shifting by not allowing the inside edges of the bass panels to shift forward. The extra thickness of a rebuilt treble panel and bass panel can make the bottom bracket difficult to install. However the top bracket should fit into place easily. The bottom bracket can be screwed in place farther forward in the frame. This causes the bracket to be tilted due to a lip in the frame. Another solution if the bracket cannot be made to fit is to bend the front outside corners outward as seen in figure 8.6.

After the two retaining brackets are installed and screwed in place, the speaker can be turned around and the panels, input transformer, and power supplies can be wired. A speaker ready to be wired is shown in figure 8.7.



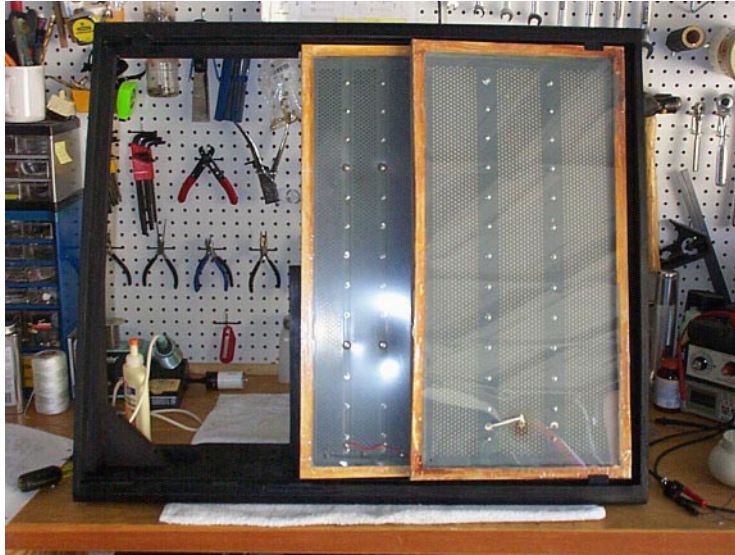


Figure 8.2: First Bass Panel Installed In Frame



Figure 8.3: Second Bass Panel Installed In Frame



Figure 8.4: Bass Panels Pushed Into Position

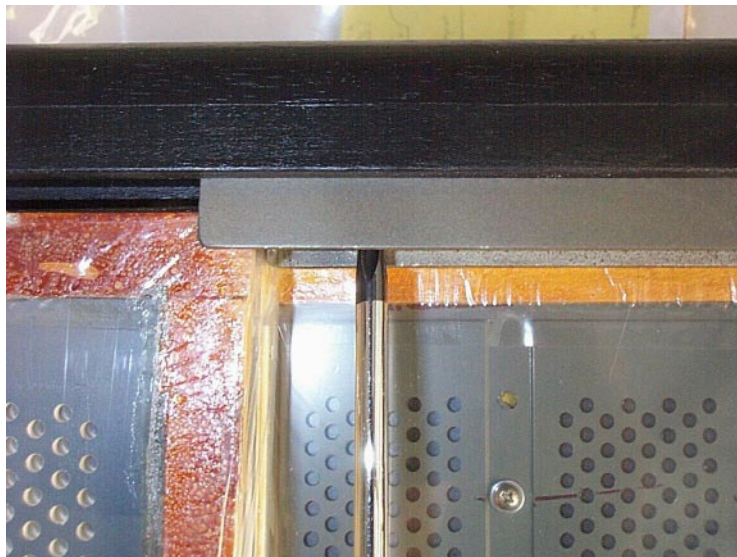


Figure 8.5: Installing the Top Retaining Bracket



Figure 8.6: Installing the Bottom Retaining Bracket



Figure 8.7: Panels Installed and Ready To Wire

## Wiring

Both bass panels in the Quad ESL are wired in parallel. This step is performed first when reassembling a speaker. In most cases the original wiring can be reused. Wiping the wiring down with alcohol to remove the decades of dirt and grime is a good idea. In cases where the wire cannot be used due to insulation damage or insufficient length, other high voltage wire can be used. Two uses for high voltage wire are television flyback wire or test lead wire, which is readily available from television repair shops or mail-order electronics catalogs. The bass panel wiring can have as much as 12,000 volts between any two leads, so high voltage wire or other insulating schemes must be employed.

The original bass panel leads are typically reused, there is a long lead and a short lead in each of the three colors (red, white, and black). The red lead is used for the bias supply, and the white and black are used for the front and back stators. It is very important that the panel are wired correctly, a mis-wiring will result in an obvious lack of performance in the assembled speaker.

The right bass panel (when viewed from the rear of the speaker), has the bias lead from the power supply attached to its center terminal. This means that on the center terminal of the terminal strip, there will be two leads connected. The left-most terminal is the rear stator, and has the long white lead attached to it. The right-most terminal is the front stator, and has the long black lead attached to it. The center terminal is the diaphragm attachment and has the long red lead and short red lead attached to it. A doubled over sheet of notebook paper carefully placed between the terminal board and the dust cover will protect the dust cover from any stray soldering iron movements or splattered solder. The five wires on the three terminals are soldered as seen in figure 8.8. After these first wires are soldered, small lengths of heat shrink tubing are slipped over the wires and slid over the terminals. It is then heat shrunk (with the notebook paper in place to protect the dust cover) as seen in figure 8.9. The three long leads are carefully fed through the holes in the vertical treble panel support members. The short white and black signal leads are attached to the left bass panel. Short lengths of heat shrink tubing are now cut and slid onto the wires. The white, red and black wires are soldered to the left panel terminal strip, after placing the folded notebook paper between the terminal board and the dust cover. After the joints have cooled, the lengths of heat shrink tubing are pushed over the terminals and shrunk. If done correctly, there should be no metal showing on the terminal strips, and the right panel should have a short and a long red lead attached to the center terminal. The left panel should have a short and long white lead attached to the left terminal and a short and a long black lead attached to the right terminal.

The input transformer can now be wired, as shown in figure 8.10. There are two different input transformer designs as seen in figure 8.11. The older (before S/N 16,000) type is shown at the top of figure 8.11, with the labeled connections

for the treble and bass panels. The newer input transformer style is shown at the bottom of figure 8.11. The required connections for the bass and treble panels are labeled. There is a third input transformer possibility that is discussed in Appendix A, which is an old style transformer which has been modified to the new circuit style. The connections for this modified transformer are shown in Appendix A. The ground wire also need to be soldered into place. Before bolting the input transformer in place, the treble panel bias wire and the ground wire should be carefully threaded through the two holes in the vertical treble supports in the speaker frame.

The original Quad ESL did not have any way of limiting the total charge on the panels over the time-constants of the audio band covered. For most linear performance an Electrostatic cell should have the diaphragm charge be constant over the whole period of an audio wave. This is easily done by placing a high value resistor in the bias supply line that charges the diaphragm. This limits the speed at which a panel will charge or discharge and also limits the charge migration to and from the panel as the diaphragm is being driven. The original panels rely on a very high diaphragm resistance to limit charge migration. This can have problems over time as the already very resistive coating ages. Rebuilt panels using the techniques described here have lower resistance diaphragms than the originals, and thus bias limiting resistors are added to the bias leads, as shown in figure 8.12. A good ballpark value of bias resistor values is  $20M\Omega$  for the pair of bass panels and  $40M\Omega$  for the treble panel. The resistors shown here are  $10M\Omega$  5% carbon film resistors. They are soldered in series and heat shrunk to the end of the treble and bass panel bias leads. The other end of the resistor strings are soldered to the power supply as shown in figure 8.13. The ground wire from the input transformer is also soldered to the power supply. Care should be taken when soldering the power transformer not to damage the bass panel dust cover. After the three connections are soldered to the power supply, it can be bolted to the frame using the original hardware.

After the power supply connections are soldered, the wires going to the power supply can be dressed for neatness as shown in figure 8.14. The input transformer is shown in figure 8.15. The finished power supply and bass panel wiring is shown in figure 8.16.

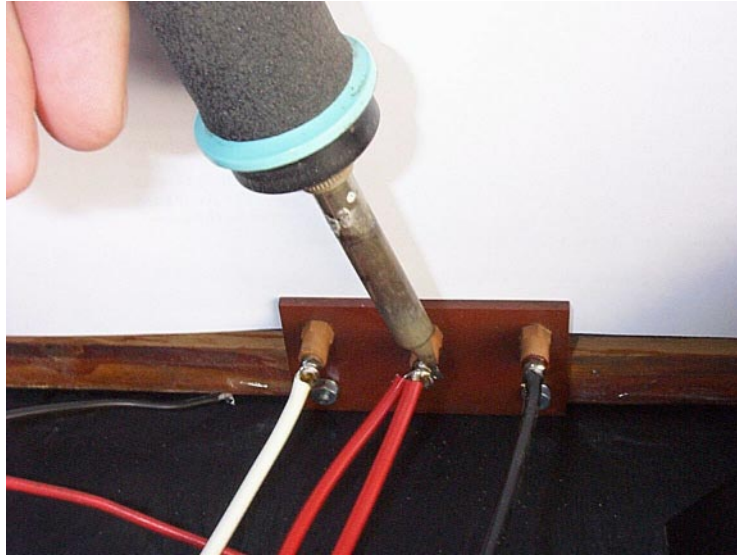


Figure 8.8: Soldering Bass Panel Wires

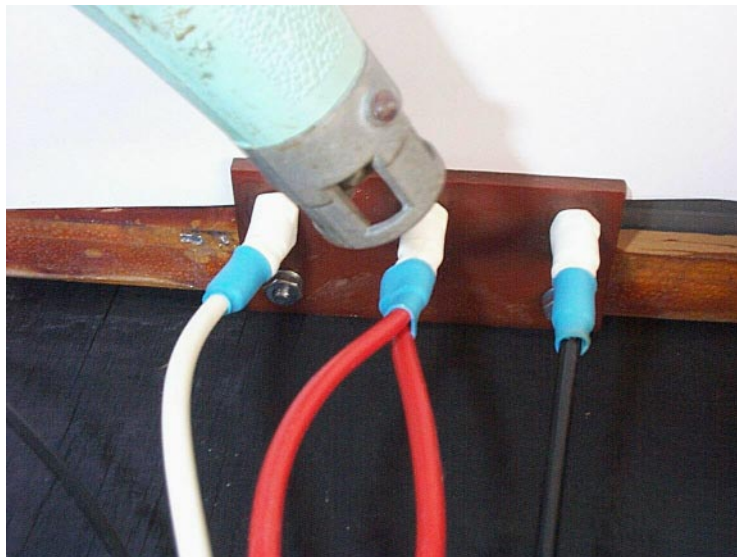


Figure 8.9: Insulating Bass Wiring With Heat Shrink Tubing

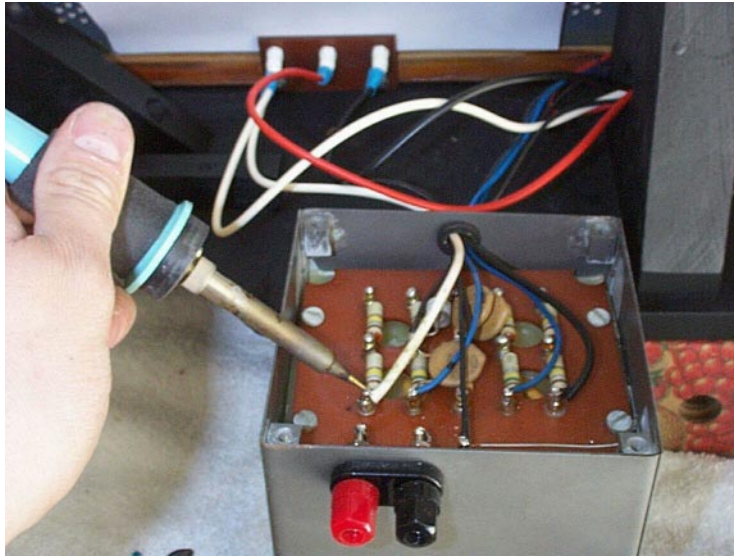


Figure 8.10: Soldering Input Transformer Connections

## Final Mechanical Assembly

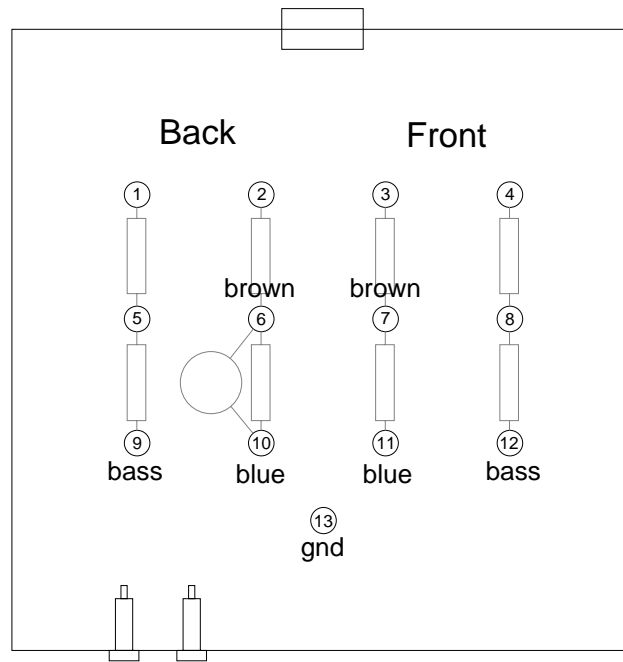
The front and back grilles can now be reinstalled. First the foam pads need to be re-glued to the front of the bass panel dust cover frames. The foam strips are attached with a suitable adhesive; rubber cement works quite well. Figure 8.17 shows the rubber cement being applied to the bass panel dust cover frames. Figure 8.18 shows the front pads being attached.

The rear damping pads need to be reattached to the treble panels. On some Quad ESL models, the felt pads are stapled through wooden strips to the treble panel. On these models, the ends of the staples can be cut off with diagonal cutters, and the wooden strips are glued to the rear treble panel dust cover frame. On models that lack the vertical wooden strips, the felt pads are stapled directly to the rear treble panel dust cover frames. Figure 8.19 shows a felt pad being stapled to the treble panel.

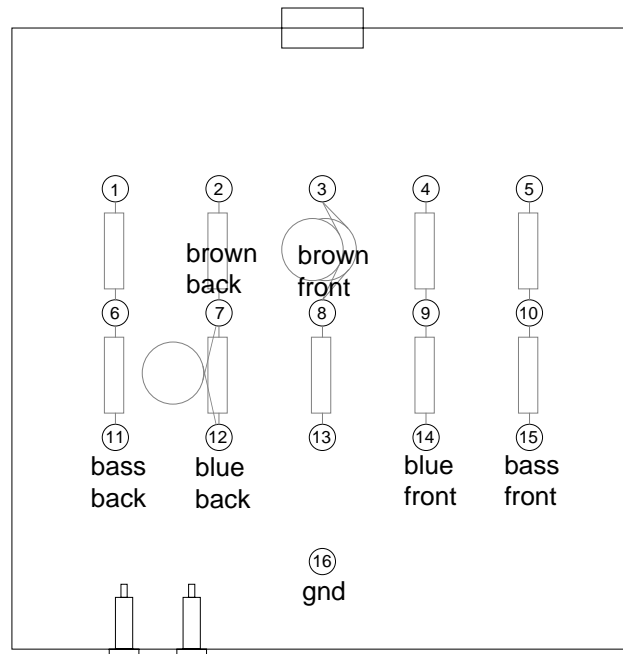
The rear grille can now be attached. It is simply set in place and screwed to the frame. Figure 8.20 shows the rear grille being screwed in place.

The front grille is installed by first placing the lip on the top of the grille front in the slot in the rear of the frame top. This is accomplished by holding the front grill away from the bottom of the frame while pushing the top of the grille into the slot in the frame. The bottom of the grille is then pulled downward and against the frame. It is then screwed to the bottom of the frame and stapled to the sides. Figure 8.21 shows a custom grill stapled to the side of the frame.

The wooden side panels can now be reattached. However the factory screws used on some ESL units were too long and actually damaged the sides of the bass panels. This is shown in figure 8.21, where the damage to the side of the bass



## Old Style



## New Style

Figure 8.11: Audio Transformer Underside & Wiring Guide





Figure 8.12: Soldering Bias Resistors In Place

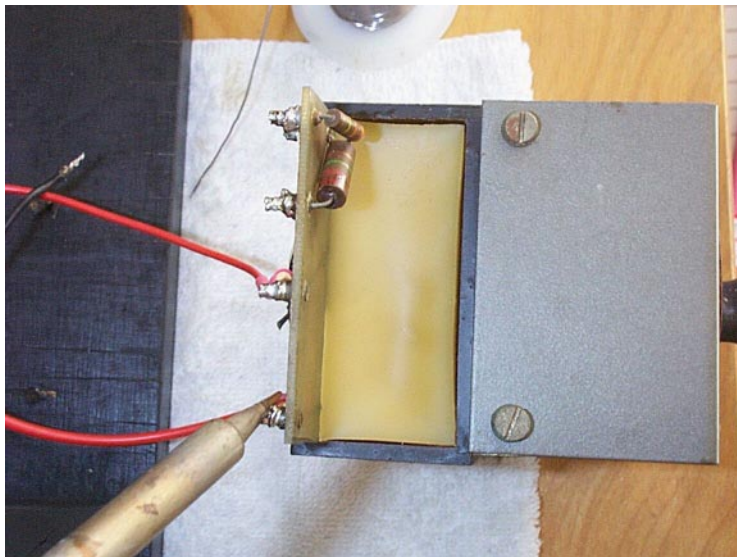


Figure 8.13: Soldering Power Supply Connections



Figure 8.14: Wiring Neatly Dressed and Ready For Final Assembly

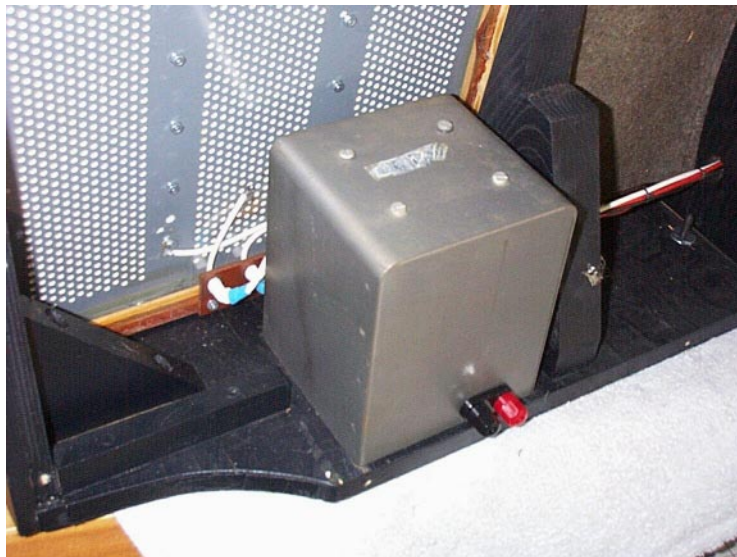


Figure 8.15: Input Transformer Finished and Bolted In Place

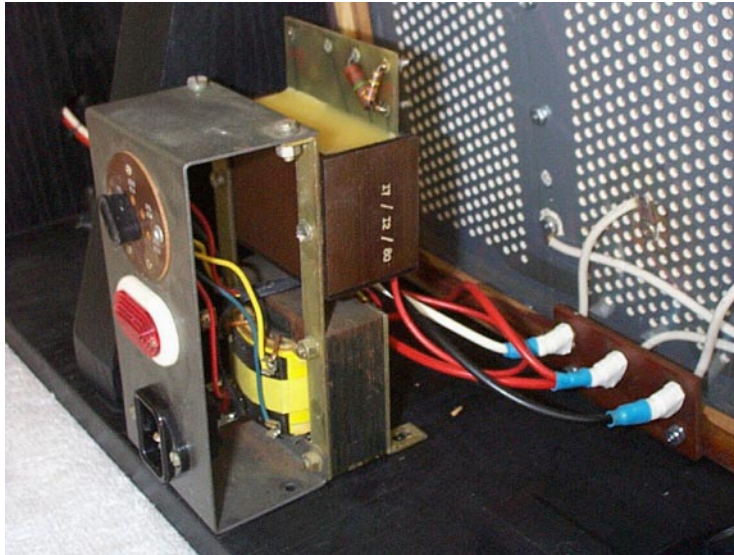


Figure 8.16: Power Supply Finished and Bolted In Place

panel can be easily seen. A simple solution if you have found damage to the bass panels before rebuilding them is to trim off the ends of screws as seen in figure 8.22. Shorter screws can also be used and are probably a better idea, although trimming the ends of the screws works quite well.



Figure 8.17: Applying Glue For Front Grille Pads

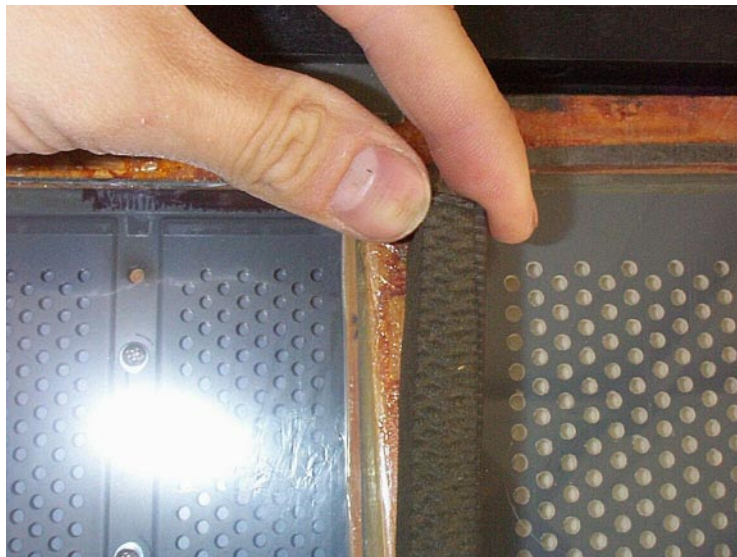


Figure 8.18: Attaching Front Grille Pads



Figure 8.19: Stapling Rear Felt To Treble Panel



Figure 8.20: Screwing The Rear Grille In Place



Figure 8.21: Problems Caused By too Long Side Panel Screws



Figure 8.22: Shortening The Side Trim Strip Screws

# Chapter 9

## Improvements & Add-Ons

Probably the biggest two improvements to the Quad ESL's are elevating them using stands and replacing the fairly opaque original grilles. The original grilles can be replaced by a variety of perforated metal or mesh screen materials. However some sort of grille should always be used, due to the high voltages present on the outside of the bass panels when in operation, and the delicate nature of the dust covers.

A good material for new grilles, particularly if grille cloth is to be used, is a coarse mesh window screening. The window screening shown in figure 9.1 has holes which are about 1/4 inch on a side. It is easily bent into shape and holds the shape well. Perforated metal with fairly large openings also works well, although it is considerably more expensive.

Figure 9.2 shows the wire mesh bent to shape and loosely fit over the top corner of an ESL frame. The mesh was painted black so it will not show under the black grille cloth. Extreme care must be taken when bending the mesh over a completed speaker, as the mesh can easily tear a dust cover. It is best to bend the mesh to shape on an empty frame. After the mesh is bent to shape, the grille cloth can be attached. This can easily be accomplished by stretching the grill cloth over the mesh and hooking it on the sharp edges of the mesh, as seen in figure 9.3. It can be sewn in place although that is not necessary. The ends of the cloth are tucked between the mesh and the frame and are thus held in place.

Figure 9.4 shows the side of the installed replacement grille stapled to the frame. The original or replacement side panels will nicely cover the staples and edges of the new grilles, producing a clean professional looking speaker.

Elevating the ESL's and aiming them at the primary listening position produces a big improvement in imaging and the sense of realism. There have been several stand designs in the past, including a commercial one from Arcici. The Arcici stands are not particularly attractive, and on occasion will not mount well of the sides of the frames are not in good condition. The most substantial portion of the ESL frames are the bottoms, and they are also the most convenient point

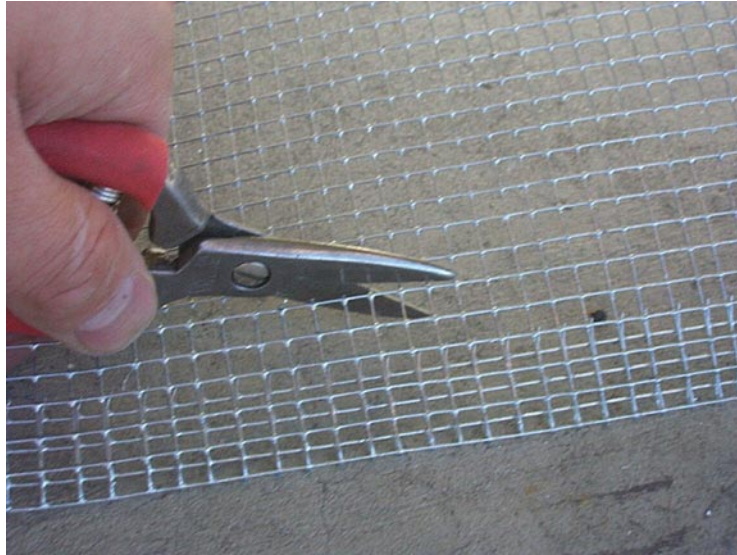


Figure 9.1: Cutting Wire Mesh To Size For Replacement Front Grilles

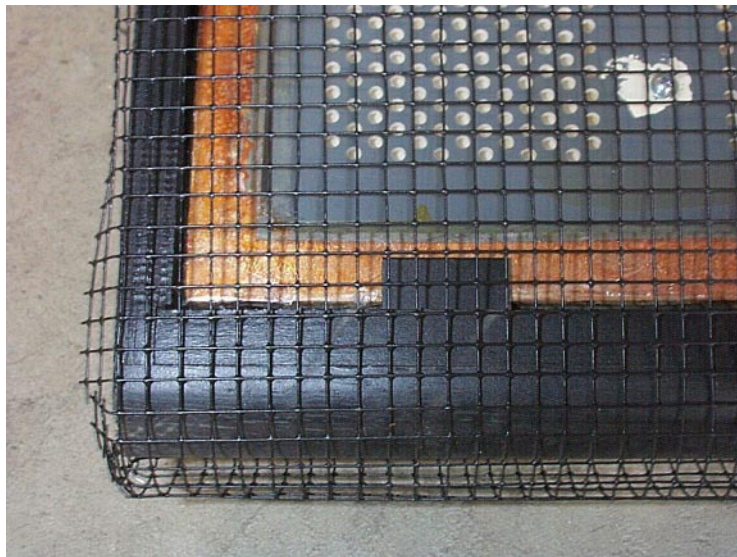


Figure 9.2: Bending Wire Mesh To Shape





Figure 9.3: Attaching The Grille Cloth To The Mesh



Figure 9.4: Stapling The Grille To the ESL Frame



Figure 9.5: Suggested Hardware For Stand Mounting

for mounting stands.

Figure 9.5 shows one type of possible hardware useful for mounting stands. The heart of the system is threaded "T" nuts that are installed inside the bottom of the frames. The holes are drilled in the frame bottoms as shown in figure 9.6. The installed T-nuts are shown in figure 9.7.

The hardware shown above to install stands works well with the stand design shown in figure 9 and figure 9.8. The location to drill the holes in the frame base and in the top of the stands. The stands are designed to use standard dimensional lumber.

The original Quad ESL's were designed during a time when 15 watts was a lot of power for a home amplifier. The ESL's were designed to be used with the 15 watt Quad II amplifier. When higher power amplifiers are used with the ESL's, there is a risk of overpowering and arcing the treble panels. When the Quad 303 amplifier was introduced, it's high power output caused problems with treble panel arcing. Quad devised a protection circuit for the treble panel, as shown in the top of figure 9.9. Many users have commented that the Quad protection circuit changes the sound of the speaker. If the diodes in the bridge fail as an open circuit, the protection circuit will not function and has no indication that it is not functioning.

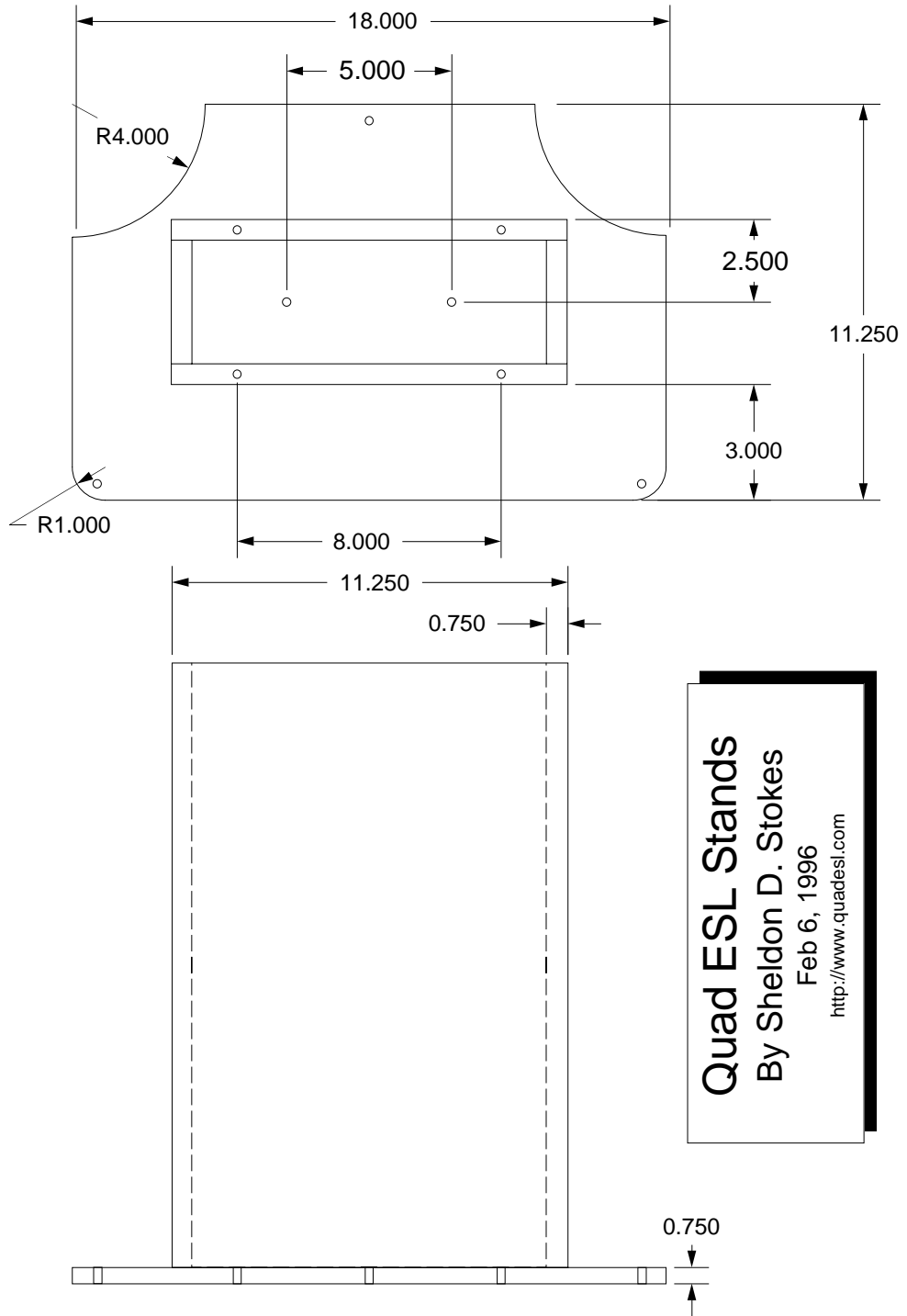
A replacement for the Quad protection circuit is shown at the bottom of figure 9.9. The circuit is a gas discharge tube, which are manufactured by a number of companies. The model number listed in figure 9.9 is from *CP Clare*. This gas discharge tube is an ideal protection device. It has a very high resistance (gigohms) and a very low capacitance (pF) when not triggered, thus it has essentially

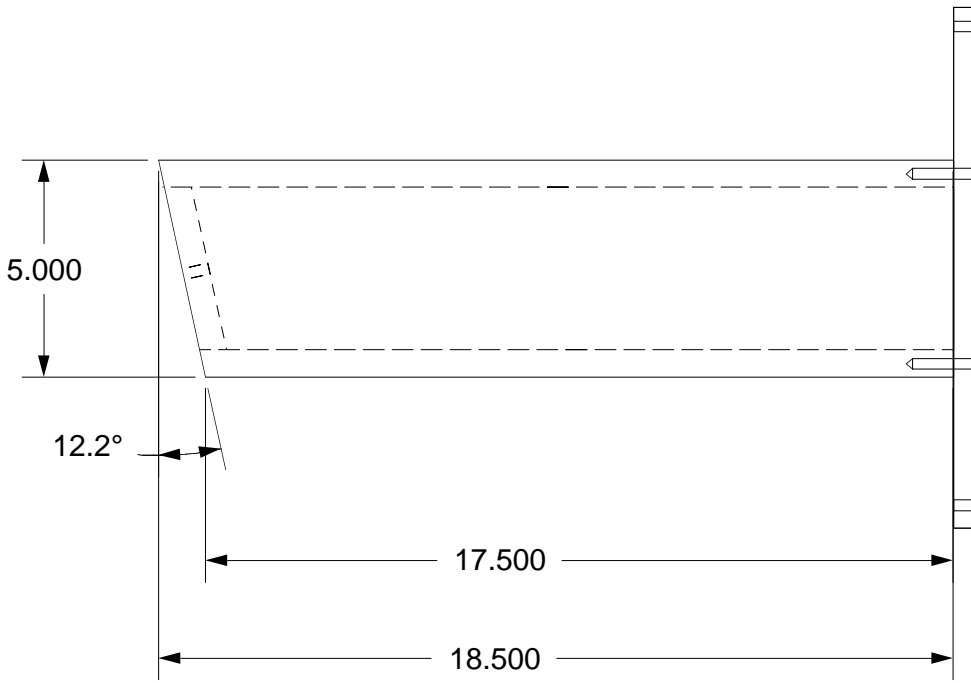


Figure 9.6: Drilling Holes For Stand Hardware



Figure 9.7: Installed Stand Hardware





**Quad ESL Stands**  
By Sheldon D. Stokes  
Feb 6, 1996  
<http://www.quadesl.com>

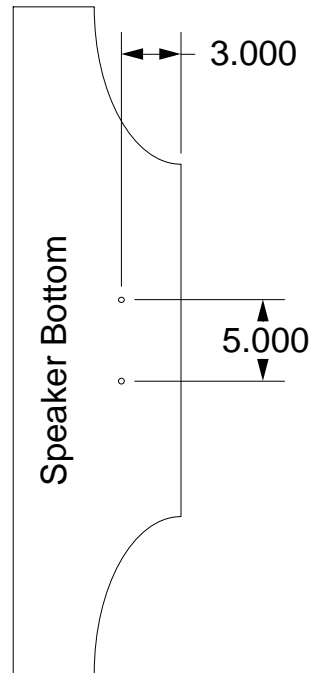
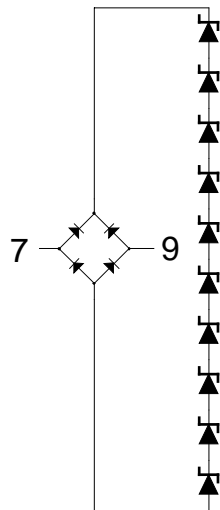


Figure 9.8: Quad ESL Stand Design

no impact on the ESL circuit performance. When the voltage across the tube is exceeded, 1500 volts in this case, the tube strikes over and is essentially a dead short, capable of sinking hundreds of amps. The device can strike over thousands of times without any damage to the device. The point of the circuit is that the tube will arc over before the treble panel does. The treble panel arcs over at about 3200 volts, however this can vary slightly from unit to unit, and also varies with humidity etc.

### Quad Treble Panel Protection Circuit



#### QUAD Parts:

Diodes: GP02-30

Zener Diodes: BZT03C220

#### Part Specs:

Diodes: 3 KV ???

Zener Diodes: 220 Volts 5 Watts

### SDS Labs Suggested Replacement:

CP Clare

CG3-1.5L

(1500 volts)

Gas Discharge Surge Protector

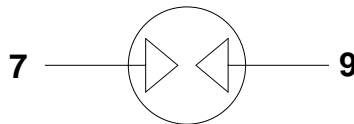


Figure 9.9: Original Quad Protection Circuit and Gas Discharge Replacement





# Chapter 10

## System & Room Considerations

The Quad ESL is an amazingly transparent and detailed speaker. It will easily show deficiencies in source components. However, it is a polite speaker, never harsh or boomy. It allows even badly recorded albums to be listened to without the sort of harsh reminders that many other high resolution speakers can possess. The user would be well served to make sure the rest of the audio system is up to the Quad ESL performance standards.

The Quad ESL was designed during a time where 15 watts was a lot of power. consequently, they are very happy with smaller amplifiers. They are a reactive load and can give many single ended tube amplifiers fits due to their low damping factor. Amplifier choices are a personal thing, and hotly debated by many. My personal preference is to drive the Quads with tube amplifiers, but this is by no means anything more than a personal preference. There are many very good sounding EL-84 (6BQ5) based amplifiers out there that work very well with the Quad's. EL-34 based amplifiers also work well, but their extra power is generally not needed. Obviously the KT-66 based Quad II amplifier works extremely well with the the ESL's. The important thing to realize when selecting an amplifier to use with the Quad ESL's is that the amp will probably never be asked to put out more than about 10-15 watts, and the amplifier will be driving a highly reactive load.

The selection of speaker wire is also hotly debated. The original input banana plugs can limit the choices somewhat. It will be tough to hook up garden hose wire to those narrowly spaced plastic banana plugs. If boutique wire is going to be used, changing the input jacks may be a good idea. My preference again is to use small mono amps and place them close to the speakers making the speaker wire issues essentially non-existent.

The Quad ESL is a dipole speaker with some rear baffling. It is also very directional at high frequencies. As a dipole, there is significant energy projected from the rear of the speaker. This means that if the speaker is placed very near a wall, the sound reproduction will be effected. The diaphragms are also effected

by the pressure field generated by a close proximity to a wall or other large object.

If room considerations permit, the speakers should be placed a couple feet away from a rear wall if not more. Due to the directionality of the high frequencies, the speakers should be aimed at the listening chair. This toe-in can be adjusted to tailor the tonal balance to the listener's taste and to slightly compensate for failings in source components (although fixing the source problem is a much better idea). For best imaging and best overall reproduction, the speakers should be placed on stands with the front face of the speaker tilted forward into a vertical position.

The speakers sound best when allowed to fully charge. A pair of speakers consumes about 3.5 watts of power to keep them charged. This value is a function of panel leakage, and will be lower in a rebuilt set of speakers. This power consumption means that it will cost about the same as a candy bar each month to leave them plugged in.

As described earlier, the charged speakers attract dust and dirt. From time to time, the speakers can be vacuumed using the brush attachment on a vacuum cleaner. For the ambitious, the rear grilles can be removed and the inside of the speaker vacuumed out. The less dirt there is near the panels, the less dirt can get pulled into the panels themselves, and the more trouble free the speakers will be long term.

# Chapter 11

## Shipping & Storage

The Quad ESL's are large speakers, there's no doubt about it. As such, shipping can be a problem. The speakers aren't as fragile as they seem, the grilles and wooden frames provide protection for the delicate parts inside. However, don't underestimate the abuse that a shipping company can inflict on a large package.

The cheapest way to ship a set of Quad ESL's is via UPS. Current UPS guidelines mandate that there should be at least 4 inches of packing on all sides of the contents for a damage claim to be covered. If a quad ESL is packed with these guidelines the resulting package is now too large to fit within the UPS size guidelines. I have had many speakers shipped to me with undersized packaging and they have arrived undamaged. If they were damaged, there is really no recourse to get them fixed if they are not packaged in accordance with UPS guidelines. In fact the original packing boxes for the Quad ESL's are considered under-packaged by UPS standards.

If the speakers are packed with lots of padding, there are other options to ship these "oversized" boxes. Yellow Freight will transport them as will the other freight carriers and moving companies. However this option is two to three times as expensive as the UPS option.

Storing the Quad ESL's does not require a lot of effort. They should be stored in the same sort of environment that furniture should be stored in. This means that they should not be stored in a moist basement, or a very hot attic. If they are going to be stored for a long time, wrapping each speaker in plastic to keep out the dust is a good idea.



# Chapter 12

## Needed Supplies & Tools

There really aren't any exotic tools needed to repair a set of ESI's. Patience and care are the keys to success. A large flat table is essential for panel rebuilding. Some people prefer to buy a piece of thick glass slightly larger than a bass panel to use as a flat surface for rebuilding. this isn't necessary if a flat sturdy work surface is available. The tools and supplies listed below are what I use, but many other types will work well.

### Supplies:

Item	Brand	Use
Clear Packing Tape	Manco	Attaching dust covers
Insulating Tape	Manco	Insulating panel edges
Masking tape	Manco	Attaching mylar to stretching jig
Epoxy	Devcon (5 minute)	Attaching diaphragm to stator
Rubber Cement	Ross	Attaching dust covers to frames
Mylar	Dupont (0.5 mil)	Treble diaphragms & dust covers
Window Film	3M (interior)	Bass diaphragm & dust covers
Heat Shrink Tubing		Bass panel connection insulation
Nuts, Washers, & Bolts	4-40 Stainless	Rivet replacements

**Tools:**

Item	Brand	Use
Stretching Jig	See Figure 4.10	Diaphragm attachment
Razor Blades	Single Edge	Removing diaphragms etc
Screw Drivers	Flat & Philips	Tightening panel bolts
Open End Wrench		Tightening panel bolts
Heat Gun	Ungar	Tensioning treble diaphragms
Hair Dryer	Conair	Tensioning bass diaphragms
Soldering Iron	Weller	Reattaching electrical connections
Staple Gun	Swingline	Speaker reassembly

**Additional Useful Tools:**

Item	Brand	Use
High Voltage Probe	Simpson	Power supply testing
Multimeter	Fluke	Speaker component testing
Function Generator	Heathkit	Speaker testing
SPL Meter	Radio Shack	Speaker testing

A useful high voltage probe can be constructed yourself using a couple high voltage, high impedance resistors. The high voltage probe shown in this document contains a 1500 megohm resistor. A pair of 750 meg resistors should cost less than \$10.00.

The supplies and tools listed above are the types used for the refurbishing the speakers shown in this book. However many other types of supplies will also work well. Good quality tape should be used, it is the one barrier that prevents dirt from entering the panels. Stainless steel nuts and bolts are a very small increase in cost over galvanized steel, and prevent corroding, as many of the steel parts are prone to in the original speakers.

The best tools that will make the refurbishing task easier is a large, well-lit, clean workspace. A sturdy flat tabletop of about 3 feet by 5 feet in size is needed. If the workspace is not flat, a piece of glass slightly larger than the bass panel can be used as a flat surface to rebuild the panels.

All the parts listed above are easy to find with the exception of the 0.5 mil Mylar. A good source for mylar is the ESL Information Exchange, the contact information is shown below. Avoid the urge to use 0.25 mil mylar, it is very difficult to get uniform results and to keep the diaphragm tensioned to satisfactory results. The high frequency roll-off of the 0.5 mil Mylar is much higher than the bandwidth

of the speaker, so the thicker mylar does not impact the speaker performance in a negative way.

The *ESL Information eXchange* provides the expensive and difficult to obtain items required to make an ESL speaker system. These include the following: Mylar to make diaphragms Audio matching transformers Power supply transformers for the bias supply. (For both domestic and overseas markets.) Parts kits for the a conventional power supply as well as a switching power supply. Other products are planned... **Note:** The ESL info exchange does not have parts for the Quad ESL's specifically, only for scratch building ESL's.

Barry Waldron  
ESL Information eXchange  
1847 Country Club Drive  
Placerville, CA 95667 U.S.A.  
esl@information4u.com  
(530) 622-1539

The Quad repair facility in the united states is QS&D in Virginia, however at the time of this writing, they are no longer fully supporting the original ESL. They can be contacted here:

QS&D  
33 McWhirt Loop #108  
Fredricksburg, Va 22406  
(540) 372-3711  
<http://www.qsandd.com>





# Appendix A

## Quad ESL Service Manual

The notes in this section are for the guidance of the engineer who has some experience of carrying out repairs to these speakers together with the necessary proper materials for the repair.

The QUAD electrostatic speaker consists of five components: two bass units, one treble unit, an audio transformer unit and an EHT supply unit. If any repairs are necessary, it should be ascertained which of the five components is the cause and that component should be either replaced complete or repaired as appropriate.

The following notes may assist diagnosis of faults:

### Loss of Sensitivity

Check the EHT voltage, which should be: Bass  $6KV \pm 7\%$ ; Treble  $1.5KV \pm 7\%$ . If low, check, by disconnecting, whether due to leakage in speaker unit or fault within EHT unit. Voltages must be checked only with electrostatic meters, as the current drawn by other types may itself damage the rectifiers.

### Distortion

- Make sure that the speaker is really at fault by comparison with a second electrostatic speaker, using a *Quad* amplifier.
- Check EHT voltage.
- Suspect intermittent breakdown in speaker units.
- Suspect intermittent breakdown in audio transformer unit. (Note: a fault in this unit is very unlikely).

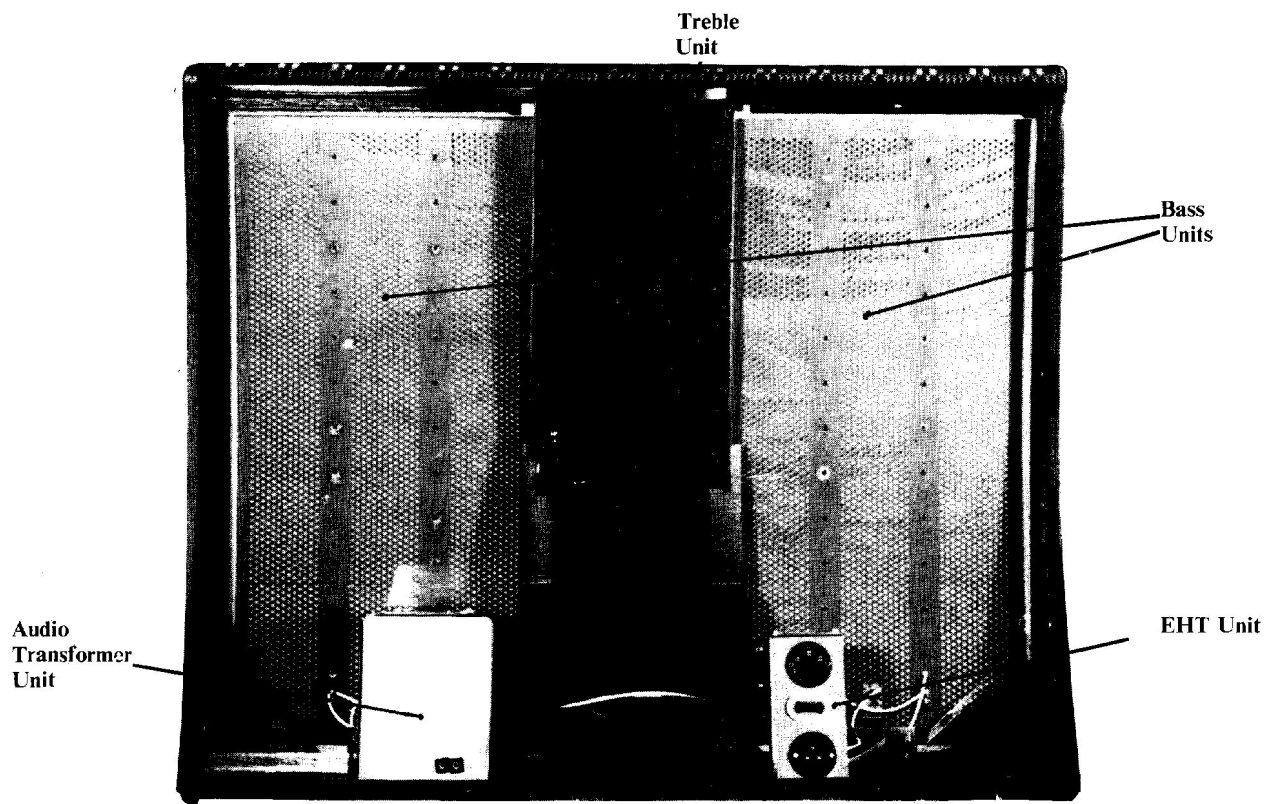


Figure A.1: Quad ESL Components

## No output at all

Suspect EHT unit or audio transformer unit after checking more obvious things like external connections, not forgetting the leads under the transformer unit connecting the input sockets.

## Background Noise

One cause of background noise in the electrostatic loudspeaker is internal discharge of the EHT supply at times of high humidity, or high voltage, or both. This may be reduced by lowering the EHT voltage and a tap is provided on the EHT mains transformer for this purpose. The connections to the EHT rectifier block are normally taken from tags marked Common and 610V. The latter is the right-hand end tag and next to it is a blank tag marked 590V to which should be transferred the lead normally connected to the 610V tag.

**Before the EHT unit is touched the mains should be completely disconnected and the loudspeaker left to stand for two hours to ensure it is completely discharged.**

Background noise may also be caused by discharge of the EHT from points external to the loudspeaker units, at the tags on the rectifier block for example, if a hair of felt or piece of fluff comes in reasonably close proximity to that point, or if a spike of solder or sharp point of wire permits corona discharge.

Where EHT leakage occurs via a bass unit, this is sometimes found to be discharging from one of the eyelets around the periphery of the bass unit plates, probably to one of the aluminium brackets. In such cases a satisfactory repair can be effected by slitting the polyethene tape round the edges of the unit, opening the dustcover frames and insulating the leak by applying a single layer of similar polyethene tape all round the periphery of the internal plates, on top of the existing sealing tape, and reassembling the dustcovers, again with polyethene tape.

Other internal failures of insulation will probably necessitate replacing the loudspeaker unit affected.

## Mechanical

If the dust seal covers should be torn, it may be necessary to replace the complete unit as there will have been ingress of dust, which causes loss of sensitivity of the unit concerned.

## Dismantling The Speaker

**The loudspeaker should be switched off for about two hours before the grilles are removed, so as to ensure the EHT unit has completely discharged.**

The component loudspeaker units of the QUAD electrostatic loudspeaker must be handled with the utmost care partly because when not supported by the rigid frame of the cabinet they are more liable to physical distortion which would reduce the small internal clearances, and partly because the dust covers are necessarily made of very thin and therefore fragile plastic film.

At the rear of the treble unit are four pins, located in the wooden struts of the cabinet, and as these represent an additional hazard to the dust covers of the treble unit, the positioning of this unit requires particular care.

Soldered joints should be smoothed and rounded and all spikes of solder, wisps of wire, etc., removed as these would tend to cause arching at the high internal voltages used.

### **Removing Front and Rear Expanded Metal Grilles**

The rear grille is held only by the screws around its periphery. For the front grille it is necessary first to remove the side mouldings, the staples through the metal beneath them, and the screws under the baseboard. Then the bottom edge of the grille is lifted gently outwards and upwards until the top rear edge may be slipped out of its groove in the cabinet, when the whole grille will be free. Care must be taken not to strain the top curved section during removal or the metal may split.

### **Replacing the Front Grille**

Replacement grilles are normally supplied cut and pre-formed so the procedure is as for refitting an existing grille. It may be found helpful when working single handed, having inserted the top back edge of the sheet into the slot in the cabinet, to hold the bottom edge of the grille under slight tension to the bottom of the wooden frame by means of elastic bands and simple hooks of wire, such as an opened paperclip, and then to use a bar of wood slightly longer than the width of the sheet, and with a good flat face, to bed the grille to the frame by moving the bar progressively down the face of the grille, tacking the sides as you go, finally securing the bottom edge with the screws removed from the old grille. Do not forget to fasten the earthing lead to the grille.

### **Replacing Bass and Treble Units**

- Remove both grilles.
- Remove the top and bottom aluminium brackets in front of the centre (treble) unit.
- If the treble unit is to be replaced, it should now be disconnected from the audio transformer (the large rectangular can on the left-hand side when

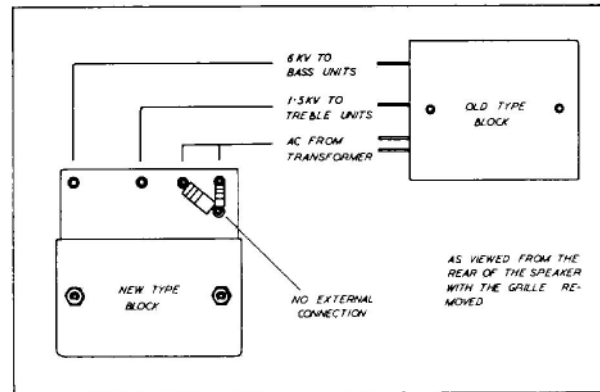


Fig. 1.

Figure A.2: Rectifier Block Types and Connections

viewed from the rear). This is held in position solely by four screws whose heads are accessible below the baseboard of the speaker. If the speaker is tilted to provide access to slacken these screws it must be restored to its upright position before they are removed or the transformer will have no support other than its connecting wires.

- Carefully prise out one bass unit and slide it past the front of the treble unit until the outer edge clears the remaining bracket at top and bottom of the cabinet.
- Either disconnect and remove the bass unit if this has to be replaced or move it far enough to enable access to be obtained to the treble unit, as required. To remove the treble unit ensure it is free of the four pins mentioned on page 3, then slide it sideways into the space vacated by the bass unit already moved and lift it out.

## EHT and Audio Transformer Units

Only the rear grille need be removed to provide access to these units. Both are secured by screws through the base board only and if the speaker is tilted to obtain access to these screw heads it must be restored to the upright position before the screws are removed or the unit will have no support other than its connecting wires.

Place a sheet of cardboard behind the EHT unit to protect the thin plastic dustcover of the bass unit from accidental damage due to specks or solder of wire ends. Etc.

Note and mark the flexible connections to the rectifier block so as to ensure correct re-connection.

To replace the rectifier block of the EHT unit, undo the two 4BA nuts securing it to the framework of the EHT unit and remove it. If the replacement block is found to be of a different type it will still be electrically and physically interchangeable with the earlier type, and the equivalent connections are shown in figure A.2. If the leads to the loudspeaker units have to be extended, the joints should be insulated with high voltage sleeving and staggered so that two joints do not lie together.

### **Reassembling the Speaker**

To reassemble, the dismantling procedure is reversed, but in addition it will be necessary to remove any wrinkles which may have appeared in the treble unit's front and rear dust covers, as these will produce audible rattles when the speaker is in use. This is achieved by means of gentle heat which thermo-sets the plastic film, and may most conveniently be applied by means of a small warm air blower, such as a hand-held dryer. The nozzle should be held about 18 from the dust cover and moved up and down the unit as uniformly as possible at a speed of about 3" per second, in regular lines so as to cover the whole area. Repeat until all wrinkles have disappeared, but always treat the whole area and do not tackle individual wrinkles separately.

A certain amount of skill is required in this operation. Obviously if the nozzle is not close enough and/or the speed of travel too great, there will not be enough heat to affect the cover. On the other hand too much heat at one point can quickly burn a hole. When carrying out this process for the first time, progressively reduce the distance and speed until the desired results are obtained.

Heat should not be applied to the bass unit covers. Any slight wrinkles in these covers will rarely have any audible effect and will in any case normally disappear as the tensions even themselves out in a few days. After thermosetting the treble unit dust covers, the damping felts behind the treble unit must be stretched and fixed so that there is no contact between them and the treble dust cover, as this will also affect reproduction.

### **Fitting New Dust Covers**

**NOTE:** The plates and dust cover material acquire a static charge and if placed in a dusty atmosphere or near any accumulation of dust it will adhere to them, with deleterious effects. Only plastic film supplied by Acoustical should be used. Specify whether for bass or treble unit when ordering.

First remove the faulty unit from speaker as described on page 4, and strip the adhesive tape from around its edges to release the two dust cover frames. On bass units carefully disconnect the three wires from the terminal board, having noted

their positions, and remove the board. Clean all loose dust cover material from the wooden frames since any pieces left to flap will buzz.

Spread enough of the new dust cover material on to any clean, solid, flat surface to leave about 6" surplus all around the frame, and hold in position with pieces of adhesive tape at each corner and at intervals along the sides as required.

The materials should not be over stretched but just tightly enough to remove the wrinkles.

Adhesive can now be applied to the frame, the frame placed into position on the material and left to dry. The adhesive should preferably be of a type which does not set brittle, such as Samual Jones' Samson C203, Evostick, etc. When this is dry, use a razor blade to trim off all surplus cover material back to the edge of the frame. The holes to the terminals should be BURNT through the film with a small soldering iron. If pierced cold the material will in time split and run the whole length of the dust cover.

When a pair of covers have been made, the unit and the covers should be blown with a jet of dry air to remove any dust particles etc., which have adhered to them, as this will cause a loss in sensitivity.

GREAT care should be taken if it is found necessary to renew any soldered joints on the plates. Anything more than a quick touch to the tags will soften the plate material and loosen the solder tag. A heat sink is helpful here.

When reconnecting to the terminals be sure not to cross wires as this will result in the failure of the speaker to work.

The unit should be replaced between the two frames and sealed with 2 wide polyethene adhesive tape all around the outside edge of the frames as before.

This completes the recovering and the unit can now be reassembled into position in the speaker.

## Modifications

At serial number 16800 (March 1966) additional filtering was added to protect the treble unit from damage due to high level low frequency signals. Earlier speakers may be modified as described below, when they are to be used with the Quad 303 or other suitable amplifiers of comparable output.

The components required can be obtained ready assembled on a tagboard, if required, and figure A.3 shows this in position under the audio transformer. Alternatively, suitable resistors and capacitors from normal servicing stocks, may be used if preferred.

Figure A.4 shows the tagboard layout from serial number 16800 onwards. Modifications to loudspeakers earlier than serial number 16800 when used with the Quad 303 amplifier:

- Remove the mains supply from the speaker and allow two hours for the EHT to discharge.

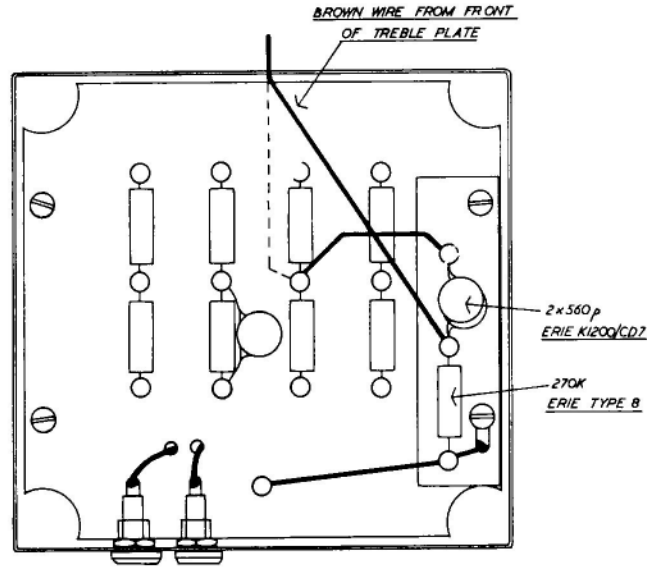


Fig. 2.

Figure A.3: Input Transformer Modification

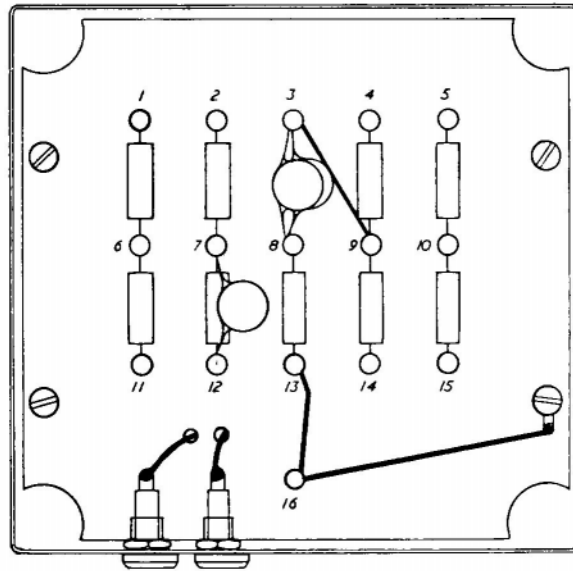


Fig. 3.

Figure A.4: New Style Input Transformer



- Undo the screws all around the periphery of the rear grille and remove the grille.
- Tilt the loudspeaker to permit access to the underside of the baseboard. taking care not to dent the front grille.
- Remove the four screws holding the audio transformer (large can on the left hand side) in place, remembering to support the transformer before it is freed or it may slip and damage the left hand bass unit dustcover.
- Restore the speaker to an upright position and invert the audio transformer, taking care not to strain its external wiring.
- Remove the two drive screws on the right-hand side of the tagboard and use these to secure the small tagboard supplied, as shown in figure A.3.
- Rewire as shown, ensuring that the brown lead which has to be stretched to reach its new anchor point does not press against any sharp edges of turret lugs or solder.
- Re-assemble the speaker in the reverse order of operations 1 to 5.

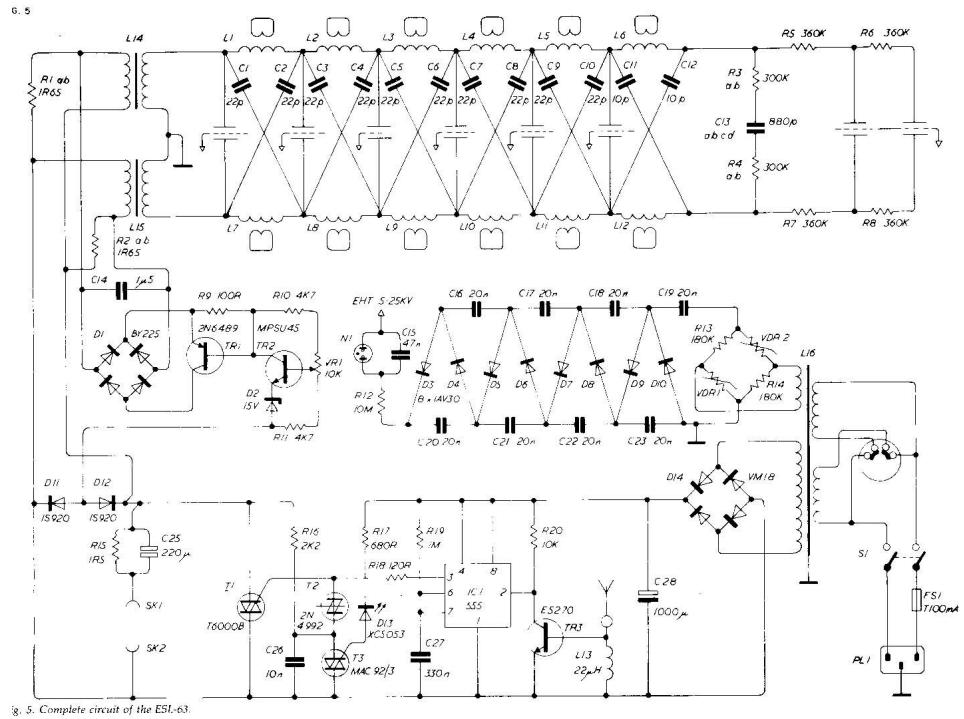


## Appendix B

### ESL 63 Information

Serving the newer Quad electrostatic speaker, the Quad ESL63, is really beyond the scope of this book, however rebuilding the panels can be done using essentially the same techniques. The schematic of the ESL63 is shown in figure B.1.

The panels are very easy to rebuild. They are held together with clips around the perimeter and two bolts through the center. The speaker dust covers come off as a unit and cover all four assembled panels. The same 0.5 mil mylar can be used to rebuild these panels as well.



g. 5. Complete circuit of the ESL-63

Figure B.1: Quad ESL63 schematic

# Bibliography

- [1] Sanders, Roger *The Sanders Electrostatic Loudspeaker*, The Audio Amateur, April 1975, pp 18-28
- [2] Sanders, Roger *The Sanders Electrostatic Amplifier*, The Audio Amateur, January 1976, pp 12-16
- [3] Sanders, Roger *Electrostatic Speaker System Part 1*, Speaker Builder, February 1980, pp 20-36
- [4] Sanders, Roger *Electrostatic Speaker System Part 2*, Speaker Builder, March 1980, pp 20-27
- [5] Sanders, Roger *Electrostatic Speaker System Part 3*, Speaker Builder, April 1980, pp 26-30
- [6] Sanders, Roger *A Compact Integrated Electrostatic/Transmission Line Part 1*, Speaker Builder, January 1990, pp 30-38,66-67
- [7] Sanders, Roger *A Compact Integrated Electrostatic/Transmission Line Part 2*, Speaker Builder, February 1990, pp 36-47,77
- [8] Sanders, Roger *A Compact Integrated Electrostatic/Transmission Line Part 3*, Speaker Builder, March 1990, pp 38-47
- [9] Sanders, Roger & McClune, Barry *The Electrostatic Loudspeaker Design Cookbook*, Audio Amateur Publications Inc. 1995 ISBN: 1-882580-00-1
- [10] Stokes, Sheldon *Refurbishing the Quad ESL (or How To Avoid Audio Burnout* Positive Feedback, Vol. 7 no. 2 pp 77-83
- [11] Wagner, Ronald *Electrostatic Loudspeaker Design And Construction* Audio Amateur Press, 1993 ISBN: 0-9624-191-6-8